



www.thekenplan.eu

vom Besten das Passende - für Theke und Catering

Holzelemente

für

Buffet und

Catering

Zusammenfassung verschiedener Lieferanten



Thekenplan Stephan Kruis - Oberer Grund 4 - D-73252 Lenningen-Schopfloch
Büro +49 (0)7026 600833 - kontakt@thekenplan.eu - www.thekenplan.eu

VALO



Auf Gastronom-Größen basierende, stapelbare Boxen und Tablett bilden das Herzstück des innovativen und erweiterbaren Buffetsystems, das zahlreiche Kombinationsmöglichkeiten nicht nur innerhalb des VALO Sortiments zulässt, sondern auch mit vielen weiteren APS Produkten. Geeignet für die vielseitige Speisenpräsentation ist VALO somit ein universelles System, das mit seinem umfangreichen und multifunktionalen Zubehörsortiment Lösungen für alle Anforderungen bietet.

Stackable boxes and trays based on the gastronorm sizes form the centrepiece of the innovative and expandable buffet system, which allows numerous possible combinations not only within the VALO range, but also with many other APS products. Suitable for versatile food presentation, VALO is thus a universal system that offers solutions for all requirements with its extensive and multifunctional range of accessories.

Las cajas y bandejas apilables basadas en tamaños gastronorm forman el núcleo del innovador y ampliable sistema de buffet, que permite numerosas posibilidades de combinación no sólo dentro de la gama VALO, sino también con muchos otros productos APS. Adecuado para la presentación versátil de fiambres, VALO es, por tanto, un sistema universal que ofrece soluciones para todos los requisitos gracias a su amplia y multifuncional gama de accesorios.

Des boîtes et des plateaux empilables, basés sur les dimensions gastronorm, constituent le cœur de ce système de buffet innovant et extensible, qui permet de nombreuses combinaisons non seulement au sein de la gamme VALO, mais aussi avec de nombreux autres produits APS. VALO est donc un système universel qui offre des solutions à toutes les exigences grâce à sa vaste gamme d'accessoires multifonctionnels.



Kombinierbar mit VALO Schieferplatten und vielen anderen Komponenten in Gastronom-Größen.

Puede combinarse con las bandejas de pizarra VALO y muchos otros componentes en tamaños Gastronom.

**GN 1/1 Holzbox**

GN 1/1 woodbox
GN 1/1 caja madera
GN 1/1 base bois



Eichenholz (geölt) / oak wood (oiled) / madera de roble (aceitada) / chêne (huilé)

	cm	↑ cm	GN	€
14000	53 x 32,5	4,5	1/1	76,00
14001	53 x 32,5	8,5	1/1	92,00
14002	53 x 32,5	16,5	1/1	136,00

**GN 1/2 Holzbox**

GN 1/2 woodbox
GN 1/2 caja madera
GN 1/2 base bois



Eichenholz (geölt) / oak wood (oiled) / madera de roble (aceitada) / chêne (huilé)

	cm	↑ cm	GN	€
14003	32,5 x 26,5	4,5	1/2	54,00
14004	32,5 x 26,5	8,5	1/2	66,00
14005	32,5 x 26,5	16,5	1/2	92,00

**GN 1/3 Holzbox**

GN 1/3 woodbox
GN 1/3 caja madera
GN 1/3 base bois



Eichenholz (geölt) / oak wood (oiled) / madera de roble (aceitada) / chêne (huilé)

	cm	↑ cm	GN	€
14006	32,5 x 17,5	4,5	1/3	46,00
14007	32,5 x 17,5	8,5	1/3	54,00

**GN 2/4 Holzbox**

GN 2/4 woodbox
GN 2/4 caja madera
GN 2/4 base bois



Eichenholz (geölt) / oak wood (oiled) / madera de roble (aceitada) / chêne (huilé)

	cm	↑ cm	GN	€
14008	53 x 16,2	4,5	2/4	60,00
14009	53 x 16,2	8,5	2/4	71,00

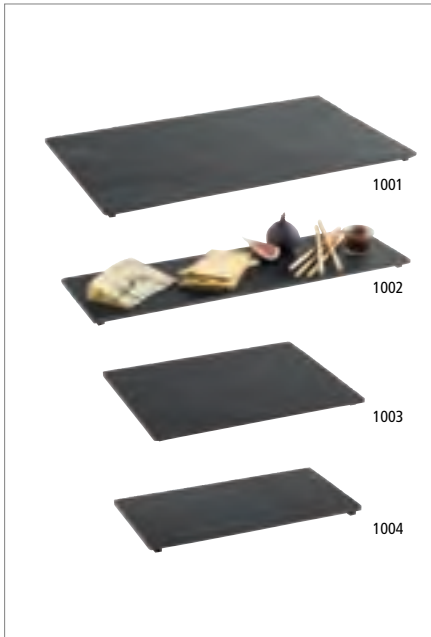

GN Naturschieferplatte

GN natural slate tray
GN bandeja de pizarra natural
GN plat ardoise naturelle



Schieferplatte mit möbelschonenden Füßchen, gerade Kanten

slate top with furniture-friendly feet, straight edges
encimera de pizarra con patas aptas para muebles, bordes rectos
plateau en ardoise avec pieds qui protègent les meubles, bords rectilignes

	cm	✂ mm	GN	€
1001	53 x 32,5	6 - 9	1/1	16,40
1002	53 x 16,2	6 - 9	2/4	6,80
1003	32,5 x 26,5	6 - 9	1/2	9,20
1004	32,5 x 17,6	6 - 9	1/3	5,60



GN Einsatz „VALO“

GN insert
GN bandeja
GN bac supérieur



passender Einsatz zu VALO GN Holzboxen, ideal zum Befüllen mit Crushed Eis

suitable insert for VALO GN wooden boxes, ideal for filling with crushed ice
bandeja para cajas de madera VALO GN, ideal para rellenar con hielo picado
bac supérieur pour caisses en bois VALO GN, idéal pour le remplissage avec de la glace pilée

	cm	↑ cm	GN	fits to	€
14041 <small>NEW</small>	51,5 x 31	6	1/1	14001	32,00
14036	51,5 x 31	14	1/1	14002	35,00
14042 <small>NEW</small>	31,0 x 25	6	1/2	14004	23,00
14037	31,0 x 25	14	1/2	14005	26,00



Einsatz für GN 1/1 Holzbox

insert for GN 1/1 woodbox
separador para GN 1/1 caja madera
insert pour GN 1/1 base bois



Einsatz mit Fächern 9,5 x 9,5 cm

insert with compartments 9,5 x 9,5 cm
bandeja con compartimentos 9,5 x 9,5 cm
insert avec compartiments 9,5 x 9,5 cm

	cm	↑ cm	fits to	€
14021	50,5 x 30	6	14001	36,00



Einsatz für GN 1/2 Holzbox, 2er Set
 insert for GN 1/2 woodbox, 2 pcs
 separador para GN 1/2 caja madera, set de 2
 insert pour GN 1/2 base bois, set de 2

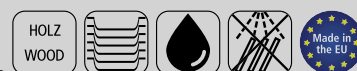

Einsatz mit drei Fächern

insert with 3 compartments
 bandeja con 3 compartimentos
 insert avec 3 compartiments

	cm	↑ cm	fits to	€
14022	24 x 10,5	6	14004	21,00

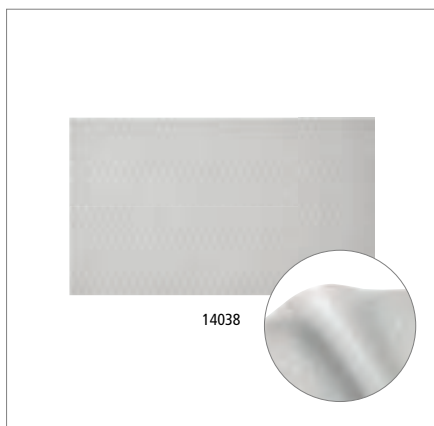

Antirutschmatte

anti-slip mat
 alfombra antideslizante
 tapis antidérapant



Passend für GN 1/1, GN 1/2, GN 2/4
 suitable for GN 1/1, GN 1/2, GN 2/4
 decuado para GN 1/1, GN 1/2, GN 2/4
 convient pour GN 1/1, GN 1/2, GN 2/4

	fits to	€
14038	GN 1/1	10,00
14039	GN 1/2	8,00
14040	GN 2/4	8,00

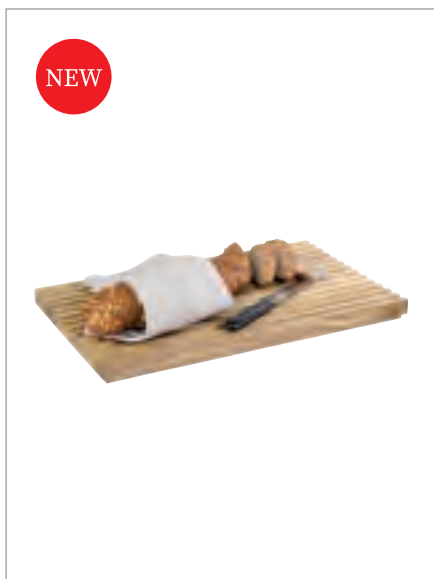

Brottschneidebrett „VALO“

cutting board
 tabla de cortar
 planche à découper



Eichenholz (geölt), mit Antirutsch-Füßchen

oak wood (oiled), with non-slip feet
 madera de roble (aceitada), con pies antideslizantes
 bois de chêne (huilé), avec pieds antidérapants

	cm	↑ cm	GN	€
00764	53 x 32,5	3,5	1/1	100,00

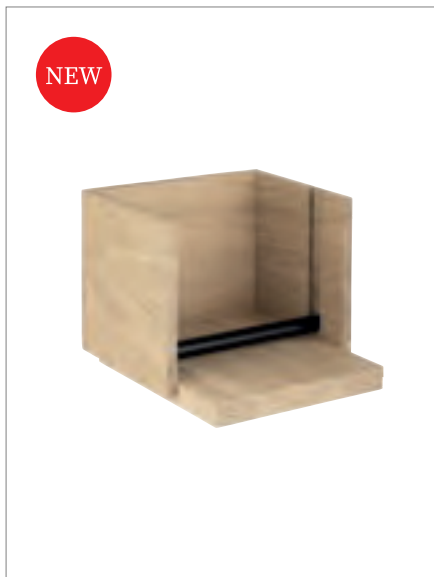

Serviettenhalter „VALO“

napkin holder
 servilletero
 porte-serviettes



Eichenholz (geölt), für ca. 100 Servietten mit 1/4 Falz, inklusive Beschwerer

oak wood (oiled), for approx. 100 napkins with 1/4 fold, including weight
 madera de roble (aceitada), para aprox. 100 servilletas con 1/4 de pliegue, con barra de contrapeso
 bois du chêne (huilé), pour env. 100 serviettes pliées en 1/4, avec barre de contrepoids

	cm	↑ cm	€
14092	19 x 19	16	59,00



stapelbar
 stackable



14030



14031



14032



14033



14034



14035

GN Buffetständer

GN buffet stand + Zubehör

GN soporte para buffet

GN présentoir buffet



- Multifunktionaler stapelbarer Buffetständer aus pulverbeschichtetem Metall
- Stecktafel
- Eckverbindung
- Podest und Schild
- Hygieneschutz

- multifunctional stackable buffet stand made of powder-coated metal
- pegboard
- corner connection
- pedestal and shield
- hygienic protection

- soporte multifuncional apilable para bufé fabricado en metal con recubrimiento en polvo
- tablero de anuncios
- conexión de esquina
- pedestal y escudo
- protección higiénica

- support de buffet multifonctionnel empilable en métal revêtu par poudre
- panneau d'affichage
- raccord d'angle
- plateforme et bouclier
- protection hygiénique

	cm	↑ cm	€
14030	57 x 37	28,5	150,00
14031	57 x 1	19,5	38,00
14032	39 x 39	3	56,00
14033	∅ 25	20,5	30,00
14034	∅ 25	33	30,00
14035	60,5 x 36,5	33,5	130,00

Kreide-Marker, Stärke 2 mm, 2er Set

chalk marker, 2 pcs.

rotulador de tiza, set de 2

marqueur a la craie liquide, set de 2



	∅ cm	↑ cm	Farbe / Colour	pcs.	€ / set
71490	1	13	White	2	6,20



NEW

**Etagère, 2-stufig „VALO“**

2-tier tray
bandeja 2 alturas
étagère carré 2 hauteurs



Eichenholz (geölt), untere Ebene 52 x 26,5 cm, obere Ebene 52 x 16 cm

oak wood (oiled), lower level 52 x 26,5 cm, upper level 52 x 16 cm

madera de roble (aceitada), nivel inferior 52 x 26,5 cm, nivel superior 52 x 16 cm

bois du chêne (huilé), niveau inférieur 52 x 26,5 cm, niveau supérieur 52 x 16 cm

	cm	↑ cm	€
14020	54 x 26,5	26,5	189,00



angewinkelte Innenbox
für ideale Präsentation
angled inner box
for ideal presentation



14012

Etagère, 3-stufig

3-tier tray
bandeja 3 alturas
étagère carré 3 hauteurs



Gestell aus Eichenholz (geölt)

oak wood frame (oiled)

marco de madera de roble (aceitada)

structure en bois du chêne (huilé)

	cm	↑ cm	fits to	€
14012	55,5 x 32,5	64	GN 1/1, 2/4	248,00



14010



14011

Etagère, 2-stufig

2-tier tray
bandeja 2 alturas
étagère carré 2 hauteurs



Gestell aus Eichenholz (geölt)

oak wood frame (oiled)

marco de madera de roble (aceitada)

structure en bois du chêne (huilé)

	cm	↑ cm	fits to	€
14010	35 x 26,5	44,5	GN 1/2, 1/3	164,00
14011	55,5 x 26,5	44,5	GN 2/4	190,00

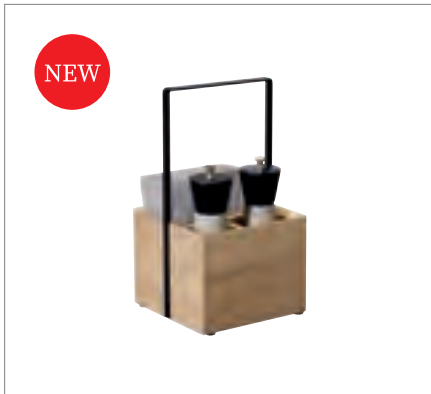

NEW

Table Caddy „VALO“

table caddy
caddy de mesa
caddy de table



Eichenholz (geölt), 3 Fächer, mit Antirutsch-Füßchen

oak wood (oiled), 3 compartments, with non-slip feet
madera de roble (aceitada), 3 compartimentos, con pies antideslizantes
bois de chêne (huilé), 3 compartiments, avec pieds antidérapants

	cm	↑ cm	€
14090	15 x 15	28	66,00



NEW

Table Caddy „VALO“

table caddy
caddy de mesa
caddy de table



Eichenholz (geölt), 3 Fächer, mit Antirutsch-Füßchen

oak wood (oiled), 3 compartments, with non-slip feet
madera de roble (aceitada), 3 compartimentos, con pies antideslizantes
bois de chêne (huilé), 3 compartiments, avec pieds antidérapants

	cm	↑ cm	€
14091	15 x 15	31	89,00



3,8 ltr.
14025

7 ltr.
14015

2 x 7 ltr.
14016

Getränkespender „VALO“

beverage dispenser
dispensador de bebidas
distributeur de boissons



Eichenholz (wasserdicht lackiert), Zapfhahn aus Edelstahl, Untersetzer aus Melamin, Bodenplatte (Gläsertablett) herausnehmbar

oak wood (waterproof lacquered), stainless steel tap, melamine coaster, removeable base plate
madera de roble (lacado impermeable), grifo de acero inoxidable, posavasos de melamina, placa base extraíble
bois de chêne (vernis imperméable), robinet en acier inox, dessous de verre en mélamine, plaque de fond amovible

	cm	↑ cm	ltr.	€
14025 NEW	18,0 x 18	41,0	3,8	200,00
14015	21,0 x 21	46,5	7	240,00
14016	43,5 x 21	46,5	2 x 7	390,00

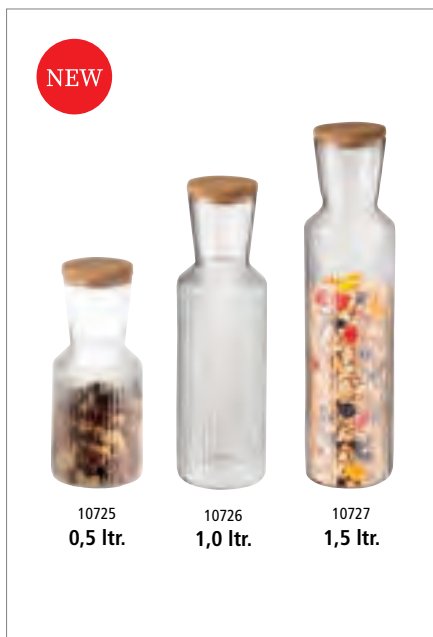
**Glaskaraffe „LINES“**

glass carafe
jarra de vidrio
carafe en verre

GLAS
GLASS

KORK
CORK

ideal für Cerealien, Säfte oder Milch, Deckel aus Kork

ideal for cereals, juices or milk, cork lid

ideal para cereales, zumos o leche, tapa de corcho

idéal pour les céréales, les jus de fruits ou le lait, couvercle en liège

	Ø cm	↑ cm	ltr.	fits to	€
10725	9	19,5	0,5	14023	16,00
10726	9	27,5	1,0	14023	23,00
10727	9	35,0	1,5	14023	24,00

**3er-Podest für Glaskaraffen „VALO“**

podest for 3 glass carafes
pedestal de 3 para jarra de vidrio
podium pour 3 pichets en verre

HOLZ
WOOD



Eichenholz (geölt), ideal für eine stets geordnete Präsentation am Buffet

oak wood (oiled), ideal for a constantly organised presentation at the buffet

madera de roble (aceitada), ideal para una presentación constantemente organizada en el bufé

chêne (huilé), idéal pour une présentation toujours ordonnée au buffet

	cm	↑ cm	fits to	€
14023	41 x 16	12	17025, 17026, 17027	49,00

**Glaskaraffe „LINES“**

glass carafe
jarra de vidrio
carafe en verre

GLAS
GLASS

KORK
CORK

ideal für Cerealien, Säfte oder Milch, Deckel aus Kork

ideal for cereals, juices or milk, cork lid

ideal para cereales, zumos o leche, tapa de corcho

idéal pour les céréales, les jus de fruits ou le lait, couvercle en liège

	Ø cm	↑ cm	ltr.	fits to	€
10738	8	28	0,75	14019	22,00

**1er-Podest für Glaskaraffen „VALO“**

podest for 1 glass carafes
pedestal de 1 para jarra de vidrio
podium pour 1 pichets en verre

HOLZ
WOOD



Eichenholz (geölt), ideal für eine stets geordnete Präsentation am Buffet

oak wood (oiled), ideal for a constantly organised presentation at the buffet

madera de roble (aceitada), ideal para una presentación constantemente organizada en el bufé

chêne (huilé), idéal pour une présentation toujours ordonnée au buffet

	cm	↑ cm	fits to	€
14019	15 x 15	12	10738	15,00



Etagère, 2+3-stufig, rund
 2+3-tier tray, round
 bandeja 2+3 alturas, en torno a
 étagère carré 2+3 hauteurs, rond
Gestell aus Eichenholz (geölt)
 oak wood frame (oiled)
 marco de madera de roble (aceitada)
 structure en bois du chêne (huilé)



	Ø cm	↑ cm		€
14013	30	28		68,00
14014	30	42		87,00



Serviertablett „VALO“
 tray
 bandeja
 plateau



Eichenholz (geölt), Innenmaß 56 x 36 cm
 oak wood (oiled), inside dimensions 56 x 36 cm
 madera de roble (aceitada), dimensiones interiores 56 x 36 cm
 bois du chêne (huilé), dimensions intérieures 56 x 36 cm

	cm	↑ cm	fits to	€
14060	60 x 40	3	14061	82,00

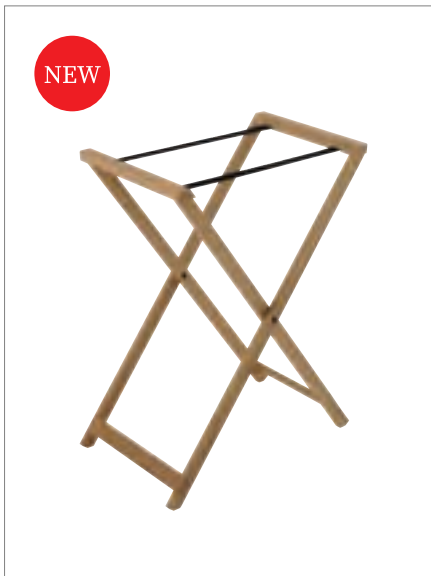

Tablettständer „VALO“
 tray stand
 soporte para bandejas
 support de plateau



Eichenholz (geölt), zusammenklappbar
 oak wood (oiled), collapsible
 madera de roble (aceitada), plegable
 bois du chêne (huilé), pliable

	cm	↑ cm	fits to	€
14061	56 x 35,5	75	14060	130,00



mit Magnetbefestigung
 with magnetic attachment



Kochplatte Ø 24 cm
induction station Ø 24 cm

4 tlg.
4 pcs.



12276



12272



12295

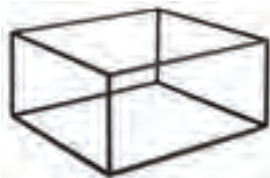

15506

Induktionsstation, 4-tlg. Set „VALO“

induction station, 4 pcs.
estación de inducción, set de 4
station d'induction, set de 4



4 teiliges Set:

- 1 Induktionskochplatte mit Regler (Ø 24 cm, 900 Watt)
- 1 Metallständer schwarz
- 1 Rahmen aus Eiche (wasserfest lackiert)
- 1 Edelstahlrahmen

4 pcs. set:

- 1 induction hotplate with controller (Ø 24 cm, 900 watt)
- 1 metal stand black
- 1 frame made of oak (water-resistant coated)
- 1 stainless steel frame

set de 4:

- 1 placa de inducción con regulador (Ø 24 cm, 900 vatios)
- 1 soporte de metal negro
- 1 caja de roble (con recubrimiento resistente al agua)
- 1 marco de acero inoxidable

set de 4:

- 1 plaque d'induction avec température réglable (Ø 24 cm, 900 watts)
- 1 support métallique noir
- 1 cadre en chêne (verni résistant à l'eau)
- 1 cadre en acier inox

	cm	↑ cm	€
12275	35,4 x 32,5	19	224,00



passendes Chafing Dish Set 12339
suitable chafing dish set 12339

Ersatzteile / replacement parts / piezas de repuesto / pièces de rechange

	cm	↑ cm		€
12276	35,4 x 32,5	8,5	Holzrahmen / wooden frame	72,00
12272	29,5 x 26,5	1	Edelstahlrahmen / stainless steel frame	22,00
12295	Ø 24	-	900 Watt Induktionskochplatte / induction plate	139,00
15506	35,4 x 32,5	17,6	Buffetständer schwarz / buffet stand black	22,80

Induktionsstation, 2-tlg. Set „VALO“

Induction station, 2-piece set
Estación de inducción, juego de 2 piezas
Station à induction, set de 2 pièces



Set, bestehend aus Induktionkochplatte 2000 Watt, inklusive Kabel-Fernbedienung, Leistung in Stufen regelbar, Rahmen aus Eichenholz (wasserfest lackiert)

set consists of induction hotplate 2000 Watt, cable remote control, power adjustable in steps, frame made of oak (waterproof lacquered)

set, compuesto por placa de inducción 2000 Watt, incluye mando a distancia por cable, potencia regulable en pasos, madera de roble (lacado impermeable)

set, composé d'une plaque de cuisson à induction 2000 watts, télécommande filaire incluse, puissance réglable par paliers, bois de chêne (verniss imperméable)

	cm	↑ cm		€
14050	39 x 39	10	2000 W	280,00

BRIDGE



Kühlbox „BRIDGE“

refrigerated buffet display
set de buffet refrigerado
présentoir buffet froid



Set bestehend aus: 1 Gestell aus Ahorn oder Wenge, 1 Behälter aus Kunststoff, 1 GN1/1 Tablett aus Melamin, 1 Kühlakku, 1 Rolltophaube (fix montiert)

set consists of: 1 base element maple or wenge, 1 plastic insert black, 1 GN1/1 tray melamine, 1 cooler, 1 cover (fixed)

set compuesto por: 1 soporte de madera arce o wengué, 1 cubeta de plástico, 1 bandeja de melamina GN 1/1, 1 acumulador de frío, 1 campana rolltop (fija)

set composé de: 1 support en bois érable ou wengé, 1 bac plastique, 1 plat en mélamine GN 1/1, 1 accumulateur de froid, 1 cloche rolltop (fixe)

	cm	↑ cm	Farbe / Colour	€
13990	63,5 x 42,5	31	Ahorn / maple	370,00
14990	63,5 x 42,5	31	Buche / beech	370,00



2 sizes
0,50 ltr. / 2,50 ltr.

14980

Melaminschale

Kühlakku

Edelstahlschale

Gestell Holz

Kühlschale „BRIDGE“

cooling bowl
bol refrigerado
bol réfrigéré



4-teilig: 1 Gestell aus Ahorn oder Wenge, 1 Behälter aus Edelstahl, 1 Schale aus Melamin (Ø 14 cm o. 23 cm), 1 Kühlakku

4 pcs.: 1 base element maple or wenge, 1 bowl stainless steel, 1 bowl melamine (Ø 14 or 23 cm), 1 cooler

set de 4: 1 soporte de madera arce o wengué, 1 cuenco de acero inoxidable, 1 cuenco de melamina (Ø 14 cm o 23 cm), 1 acumulador de frío

set de 4: 1 support en bois érable ou wengé, 1 bol en acier inox, 1 bol en mélamine (Ø 14 cm ou 23 cm), 1 accumulateur de froid

	cm	↑ cm	ltr.	Farbe / Colour	€
14980	18,5 x 18,5	10	0,5		65,00
14981	27,5 x 27,5	14	2,5		124,00

**Besteckbehälter „BRIDGE“**

cutlery organizer
cajón para cubiertos
bac à couverts



2 teiliges Set: 1 Gestell, 1 Besteckbehälter (Nr. 11955), herausnehmbar

2 pcs.: 1 base element, 1 removable plastic container (item 11955)

set de 2: 1 soporte, 1 cajón para cubiertos (ref. 11955) extraíble

set de 2: 1 support, 1 bac à couverts (réf. 11955) amovible

	cm	↑ cm	Farbe / Colour		€
13995	57,5 x 37	12		Ahorn / maple	94,00
14995	57,7 x 37	12		Buche / beech	94,00

**Cerealienspender „BRIDGE“**

cereal dispenser
dispensador de cereales
distributeur de céréales



Behälter herausnehmbar, „Feierabend-Deckel“ für das aromadichte Lagern, Portionieren durch einfaches Drehen

removable canister, special lid to keep the cereals fresh, easy to use, rotate the button to get the muesli

contenedor extraíble, tapa especial para mantener los cereales frescos, fácil de usar, se gira el pomo para servir los cereales

réceptacle amovible, couvercle spécial pour conserver les céréales, usage facile en tournant le bouton

	cm	↑ cm	ltr.	Farbe / Colour		€
13987	21 x 20	55,5	4,5		Ahorn / maple	114,00
14987	21 x 20	55,5	4,5		Buche / beech	114,00

13987 4,5 ltr.

14987 4,5 ltr.



Milchdispenser „BRIDGE“

milk dispenser
dispensador de leche
distributeur à lait



Edelstahl Dispenser mit 1 Kühlakku im Standfuß inklusive touchless adapter

stainless steel dispenser with 1 cooling element in stand including touchless adapter
dispensador de acero inoxidable con 1 acumulador de frío en la base y con adaptador sin contacto para grifo
distributeur en acier inox avec 1 accumulateur de froid dans le socle et avec adaptateur sans contact manuel

	cm	↑ cm	ltr.	Farbe / Colour	€
10836	31 x 20	39	3		Ahorn / maple 279,00
10838	39 x 22	45	5		Ahorn / maple 444,00



Milchdispenser „BRIDGE“

milk dispenser
dispensador de leche
distributeur à lait



Edelstahl Dispenser mit 1 Kühlakku im Standfuß inklusive touchless adapter

stainless steel dispenser with 1 cooling element in stand including touchless adapter
dispensador de acero inoxidable con 1 acumulador de frío en la base y con adaptador sin contacto para grifo
distributeur en acier inox avec 1 accumulateur de froid dans le socle et avec adaptateur sans contact manuel

	cm	↑ cm	ltr.	Farbe / Colour	€
10837	31 x 20	39	3		Buche / beech 279,00
10839	39 x 22	45	5		Buche / beech 444,00



Saftdispenser „BRIDGE“

juice dispenser
dispensador de zumo
distributeur à jus



Kühlung durch 2 Kühlakkus von oben und unten

cooling with 2 cooling elements from the top and base
2 acumuladores de frío: 1 en la base y 1 en la tapa
2 accumulateurs de froid: 1 dans le couvercle et 1 dans le socle

	cm	↑ cm	ltr.	Farbe / Colour	€
10870	31,0 x 20	42	4		Ahorn / maple 239,00
10871	35,5 x 22	50	6		Ahorn / maple 279,00



inklusive 3 Magnetschilder: ORANGE, APPLE, GRAPEFRUIT
including 3 magnetic signs: ORANGE, APPLE, GRAPEFRUIT



Saftdispenser „BRIDGE“

juice dispenser
dispensador de zumo
distributeur à jus



Kühlung durch 2 Kühlakkus von oben und unten

cooling with 2 cooling elements from the top and base
2 acumuladores de frío: 1 en la base y 1 en la tapa
2 accumulateurs de froid: 1 dans le couvercle et 1 dans le socle

	cm	↑ cm	ltr.	Farbe / Colour	€
10872	31,0 x 20	42	4		Buche / beech 239,00
10873	35,5 x 22	50	6		Buche / beech 279,00



inklusive 3 Magnetschilder: ORANGE, APPLE, GRAPEFRUIT
including 3 magnetic signs: ORANGE, APPLE, GRAPEFRUIT



Buffetgestell „TRIANGLE“

buffet stand
expositor de buffet
présentoir buffet



Buche massiv, 3 Ebenen: 1.: 53 x 19 cm, 2.: 40 x 17,5 cm, 3.: 30 x 15 cm
 beech maple, 3 levels: 1.: 53 x 19 cm, 2.: 40 x 17,5 cm, 3.: 30 x 15 cm
 haya sólido, 3 niveles: 1.: 53 x 19 cm, 2.: 40 x 17,5 cm, 3.: 30 x 15 cm
 hêtre massif, 3 niveaux: 1.: 53 x 19 cm, 2.: 40 x 17,5 cm, 3.: 30 x 15 cm

	cm	↑ cm	Farbe / Colour	€
13966	53 x 21	50		145,00
14966	53 x 21	50		145,00



Buffet Box „SEWING BASKET“

buffet box
caja de buffet
boîte de buffet



aus geöltem Eichenholz, 3 Fächer: 33 x 27 cm, H: 7 cm, passend für GN 1/2
 made of oiled oak wood, 3 compartments: 33 x 27 cm, H: 7 cm, suitable for GN 1/2
 de madera de roble aceitada, 3 compartimentos: 33 x 27 cm, H: 7 cm, para GN 1/2
 en bois de chêne huilé, 3 compartiments: 33 x 27 cm, H: 7 cm, pour GN 1/2

	cm	↑ cm	Farbe / Colour	€
11711	36 x 29	28	natural oak	308,00
11712	36 x 29	28	dark oak	308,00

geschlossen | closed
37 x 29 cm, H: 28 cm

geöffnet | open
70,5 x 37 cm, H: 53,5 cm



Die stapelbaren Wendeboxen lassen sich rutschfest stapeln und mit flachen GN Platten verbinden und einzeln nutzen. Individuell können Buffet-landschaften gebaut werden.

The stackable and non-slip reversible boxes can be connected to flat GN trays and can also be used individually. Different and individual buffet sceneries can be built up.

Las cajas girables y apilables son antideslizantes y se pueden conectar con bandejas planas GN o utilizar individualmente. Se pueden construir diferentes paisajes de buffet muy individuales.

Les boîtes de tournage empilables sont antiglissantes et peuvent être connectées avec des plateaux plats GN ou utilisées individuellement. Des paysages de buffet très personnalisés peuvent être construits.



GN 1/1 „SUPERBOX“



Akazienholz / acacia wood / madera de acacia / bois d'acacia

	cm	↑ cm	GN	Farbe / Colour	€
11620	55,5 x 35,0	10,5	1/1		46,00
11626	55,5 x 35,0	10,5	1/1		46,00
11721	55,5 x 35,0	20,0	1/1		70,00
11723	55,5 x 35,0	20,0	1/1		70,00



GN 2/4 „SUPERBOX“



Akazienholz / acacia wood / madera de acacia / bois d'acacia

	cm	↑ cm		Farbe / Colour	€
11623	55,5 x 18,5	10,5			38,00
11629	55,5 x 18,5	10,5			38,00



GN 1/2 „SUPERBOX“



Akazienholz / acacia wood / madera de acacia / bois d'acacia

	cm	↑ cm	GN	Farbe / Colour	€
11621	35,0 x 29,0	10,5	1/2		30,00
11627	35,0 x 29,0	10,5	1/2		30,00
11722	35,0 x 29,0	20,0	1/2		45,00
11724	35,0 x 29,0	20,0	1/2		45,00



GN 1/4 „SUPERBOX“

Akazienholz / acacia wood / madera de acacia / bois d'acacia



	cm	↑ cm	Farbe / Colour	€
11622	29 x 18,5	10,5		23,00
11628	29 x 18,5	10,5		23,00



Beschriftungsschilder, 2er Set

inscription labels, 2 pcs.
étiquettes d'inscription, set de 2
etiquetas de inscripción, set de 2



	cm	↑ cm	Farbe / Colour	€ / set
11719	8 x 1,5	5,5		8,80



Kreide-Marker, Stärke 2 mm, 2er Set

chalk marker, 2 pcs.
rotulador de tiza, set de 2
marqueur a la craie liquide, set de 2



	Ø cm	↑ cm	pcs.	Farbe / Colour	€ / set
71490	1	13	2		6,20



Buffetgestell

buffet stand
soporte para buffet
présentoir buffet

Metall, schwarz, passend für GN Boxen, mit Antirutschfüßchen

metal, black, suitable for GN boxes, with non-slip feet

metal, negro, para cajas GN, con pies antideslizantes

métal, noir, pour boîtes GN, avec pieds antidérapantsw



	cm	↑ cm	suitable for	Farbe / Colour	€
30329	29 x 32,5	48	GN 1/2 boxes, height 10,5 cm		42,00
30331	49 x 38,5	48	GN 1/1, GN 1/2 boxes		50,00



Präsentationsmöglichkeit
presentation example

4 tlg.
4 pcs.



11540



11010

Buche, wasserfest lackiert
beech wood lacquered



10791

Kühlakku halten Ihre Speisen über lange Zeit kühl
coolers keep the food cool for a long time

Buffetvitrine „TOP FRESH GN 1/1“

refrigerated buffet display
expositor buffet frío
plateau buffet froid



4-teilig: 1 Box aus Buchenholz mit Kunststoffwanne + 1 Edelstahl-Tablett GN 1/1 + 2 Kühlakkus, ohne Haube

4 pcs.: 1 beech wood box with plastic insert + 1 stainless steel tray GN 1/1 + 2 coolers, without cover

set de 4: 1 caja de madera de haya con bandeja de plástico + 1 bandeja de acero inoxidable GN 1/1 + 2 acumuladores de frío, sin campana

set de 4: 1 boîte en bois de hêtre avec bac en plastique + 1 plateau en acier inox GN 1/1 + 2 accumulateurs de froid, sans cloche

	cm	↑ cm	€
11540	60 x 41	5	189,00

GN Rolltophaube mit Chromgriff / GN rolltop cover with chrome handle / GN campana rolltop con asa cromada / GN cloche rolltop avec poignée chromée

	cm	↑ cm	GN	€
11010	53 x 32,5	19	1/1	64,00

Kühlakku / cooler / acumulador de frío / accumulateur de froid

	cm	↑ cm	€
10791	25 x 19	2,5	8,40

12 tlg.
12 pcs.



11541

Buche, wasserfest lackiert
beech wood lacquered



10791

Kühlakku halten Ihre Speisen über lange Zeit kühl
coolers keep the food cool for a long time

Buffetvitrine „DOPPELDECKER GN 1/1“

cooling buffet display
expositor buffet frío
vitrine buffet



12-teilig: 2 Boxen aus Buchenholz mit Kunststoffwanne + 2 Edelstahl-Tabletts GN 1/1 + 4 Kühlakkus + 4 verchromte Stangen, ohne Hauben

12 pcs.: 2 beech wood boxes with plastic insert + 2 stainless steel trays GN 1/1 + 4 coolers + 4 chrome-plated bars, without covers

set de 12: 2 cajas de madera de haya con bandeja de plástico + 2 bandejas de acero inoxidable GN 1/1 + 4 acumuladores de frío + 4 barras cromadas, sin campanas

set de 12: 2 boîtes en bois de hêtre avec bac en plastique + 2 plateaux en acier inox GN 1/1 + 4 accumulateurs de froid + 4 barres chromées, sans cloches

	cm	↑ cm	€
11541	60 x 41	36	348,00

GN Rolltophaube mit Chromgriff / GN rolltop cover with chrome handle / GN campana rolltop con asa cromada / GN cloche rolltop avec poignée chromée

	cm	↑ cm	GN	€
11010	53 x 32,5	19	1/1 Chrom-Griff	64,00

Kühlakku / cooler / acumulador de frío / accumulateur de froid

	cm	↑ cm	€
10791	25 x 19	2,5	8,40

DRAWER SET



50807
2 x Korb, schwarz



00910
3-teiliges Set
3 pcs. set

3 tlg.
3 pcs.



00910



00911
mit Antirutsch Füßchen
with non-slip feet



00912

Schubladen Set, 3-teilig

drawer set, 3 pcs.
cajonera, set de 3
set tiroir, set de 3

3-teiliges Set:

- 1 Ständer aus Metall schwarz
- 1 Schublade mit Griff schwarz
- 1 Schneidebrett aus geöltem Walnussholz

3 pcs. set:

- 1 stand made of metal black
- 1 drawer with handle black
- 1 oiled walnut wood cutting board

set de 3:

- 1 soporte de metal negro
- 1 cajón con asa negra
- 1 tabla de cortar de madera de nogal engrasada

set de 3:

- 1 support métallique noir
- 1 tiroir avec poignée noire
- 1 planche à découper en bois de noyer huilé

HOLZ WOOD ACRYL ACRYLIC METALL

	cm	↑ cm	€
00910	35,4 x 32,5	20	174,00



15506

00912



00911

Präsentationsmöglichkeit
presentation example

Einzelteile / parts / piezas / pièces

	cm	↑ cm		€
00911	35,4 x 32,5	3,5	Schneidebrett / cutting board	77,00
00912	34,0 x 32,0	17,5	Schublade, Griff schwarz / drawer, handle black	82,00
00914	34,0 x 32,0	17,5	Schublade, Griff chrom / drawer, handle chrome	82,00
15506	35,4 x 32,5	17,6	GN Buffetständer schwarz/ GN buffet stand black	22,80

SNACKPRESENTER

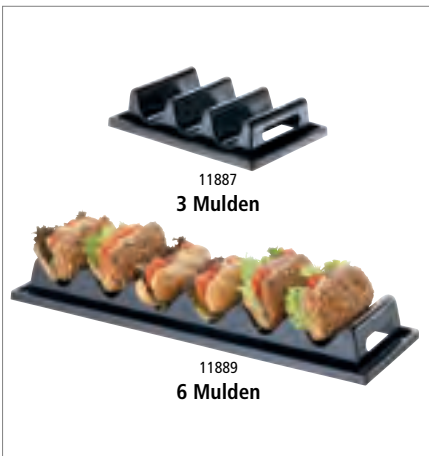

Snackpresenter

snackpresenter
dispensador de bocadillos
présentoir à sandwiches
mit Safrille und Griffmulde, passend für Vitrine 11888



with recessed grip, suitable for showcase 11888
asa moldeada, apto para la vitrina 11888
anse moulée, apte pour vitrine 11888

	cm	↑ cm		€
11887	29 x 19	6,5	3 Mulden / 3 compartments 3 compartimentos / 3 compartments	22,00
11889	60 x 19	7,5	6 Mulden / 6 compartments 6 compartimentos / 6 compartments	25,00



Snackpresenter

snackpresenter
dispensador de bocadillos
présentoir à sandwiches
hochglanzpoliert, mit Griffmulde, für 7 Baguettes



mirror polished, with recessed grip, for 7 baguettes
pulido brillante, con asa empotrada, ideal para 7 bocadillos
poli brillant, avec poignée encastrée, parfait pour 7 sandwiches

	cm	↑ cm		€
11891	47,5 x 10,5	6		32,00



Snackpresenter

snackpresenter
dispensador de bocadillos
présentoir à sandwiches



	cm	↑ cm		€
11969	56 x 8	5,5		14,00



Vitrine / Thekenaufsatz

showcase
vitrina de mostrador
vitrine de comptoir
rutschfest, aus einem Teil gefertigt



non-slip, monoblock produced
antideslizante, fabricado en 1 pieza
antidérapante, fabriquée en une seule pièce

	cm	↑ cm		€
11888	63,5 x 25	25		89,00

PERFECTO

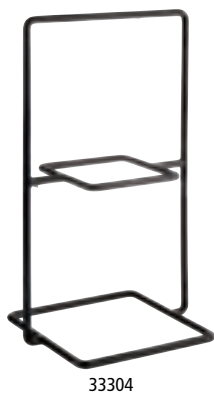

2-stufige Etagère „PERFECTO SMALL“

2-tier tray
bandeja dos alturas
étagère carré 2 hauteurs



3-teiliges Set, bestehend aus:

- 1 Buffetständer, Metall, PVC, schwarz, 23 x 19 cm, H: 40,5 cm
- 2 Bretter aus Eichenholz, geölt, 20 x 20 cm, H: 2 cm

3 pcs., consisting of:

- 1 buffet stand, metal, PVC, black, 23 x 19 cm, h: 40,5 cm
- 2 boards, oiled oak, 20 x 20 cm, h: 2 cm

set de 3, compuesto por:

- 1 soporte buffet, metal, PVC, negro, 23 x 19 cm, a: 40,5 cm
- 2 tablas de roble, aceitadas, 20 x 20 cm, a: 2 cm

set de 3, composé de :

- 1 support de buffet, métal, PVC, noir, 23 x 19 cm, h: 40,5 cm
- 2 planches en bois de chêne, huilées, 20 x 20 cm, h: 2 cm

	cm	↑ cm	€
33300	20 x 23	40,5	52,00

Brett aus Eichenholz / oak board / tabla de roble / planche en chêne

	cm	↑ cm	€
33302	20 x 20	2	15,00

Buffetständer / buffet stand / soporte de buffet / support de buffet

	cm	↑ cm	€
33304	19 x 23	40,5	25,00



Präsentationsmöglichkeit
presentation example

4 tlg.
4 pcs.

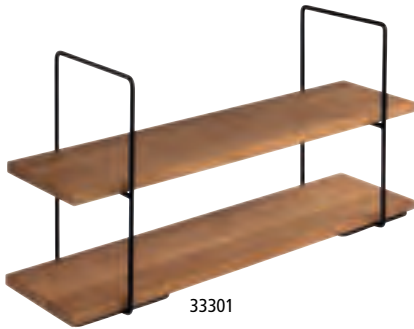

33301



33303



33304

2-stufige Etagère „PERFECTO LARGE“

2-tier tray
bandeja dos alturas
étagère carré 2 hauteurs



4-teiliges Set, bestehend aus:

- 2 Buffetständer, Metall, PVC, schwarz, 23 x 19 cm, H: 40,5 cm
- 2 Bretter aus Eichenholz, geölt, 80 x 20 cm, H: 2 cm

4 pcs., consisting of:

- 2 buffet stands, metal, PVC, black, 23 x 19 cm, h: 40,5 cm
- 2 boards, oiled oak, 80 x 20 cm, h: 2 cm

set de 4, compuesto por:

- 2 soportes buffet, metal, PVC, negro, 23 x 19 cm, a: 40,5 cm
- 2 tablas de roble, aceitadas, 80 x 20 cm, a: 2 cm

set de 4, composé de :

- 2 supports de buffet, métal, PVC, noir, 23 x 19 cm, h: 40,5 cm
- 2 planches en bois de chêne, huilées, 80 x 20 cm, h: 2 cm

	cm	↑ cm	€
33301	80 x 23	40,5	160,00

Brett aus Eichenholz / oak board / tabla de roble / planche en chêne

	Ø cm	↑ cm	€
33303	80 x 20	2	58,00

Buffetständer / buffet stand / soporte de buffet / support de buffet

	cm	↑ cm	€
33304	19 x 23	40,5	25,00



Präsentationsmöglichkeit
presentation example

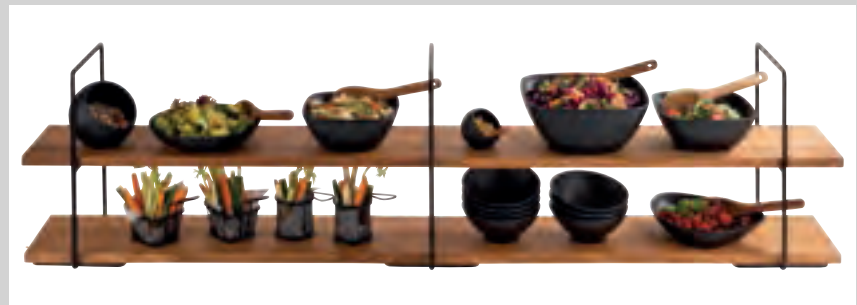

Präsentationsmöglichkeit 3 Buffetständer + 4 Bretter
presentation example 3 buffet stands / 4 boards

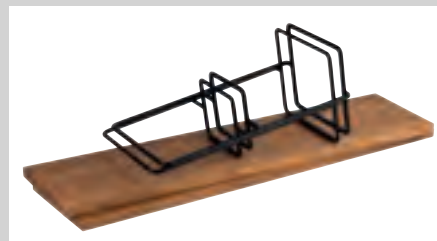

platzsparend
space saving

SERVING STANDS

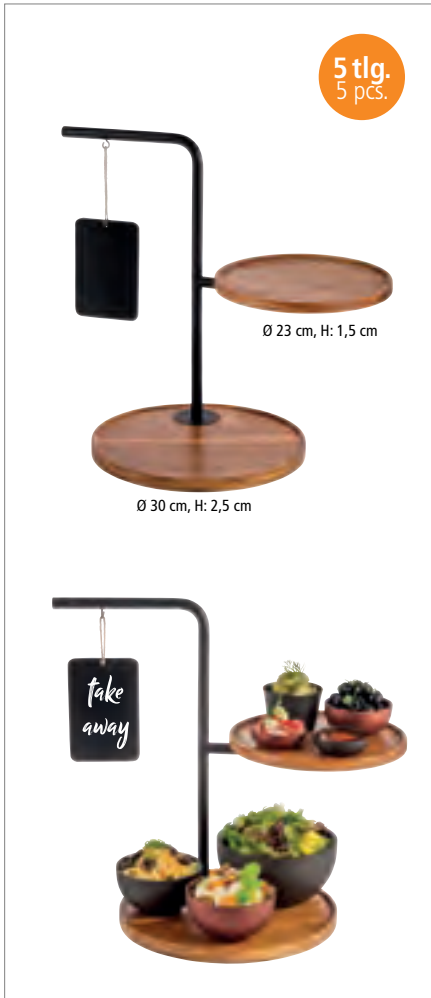

2-stufige Etagère „IRON“

2-tier tray
bandeja con dos alturas
étagère carré 2 hauteurs

1 Gestell aus schwarzem Metall
2 Akazienholzplatten: Ø 23 cm, H: 1,5 cm / Ø 30 cm, H: 2,5 cm
2 Beschriftungsschilder 15 x 10,5 cm

1 black metal frame
2 acacia wood panels: Ø 23 cm, H: 1,5 cm / Ø 30 cm, H: 2,5 cm
2 inscription labels 15 x 10.5 cm

1 soporte metálico negro
2 tablas de madera de acacia: Ø 23 cm, H: 1,5 cm / Ø 30 cm, H: 2,5 cm
2 etiquetas de inscripción 15 x 10,5 cm

1 support métallique noir
2 panneaux en bois d'acacia: Ø 23 cm, H: 1,5 cm / Ø 30 cm, H: 2,5 cm
2 étiquettes d'inscription 15 x 10,5 cm



	cm	↑ cm	€
30334	47 x 30	44	80,00

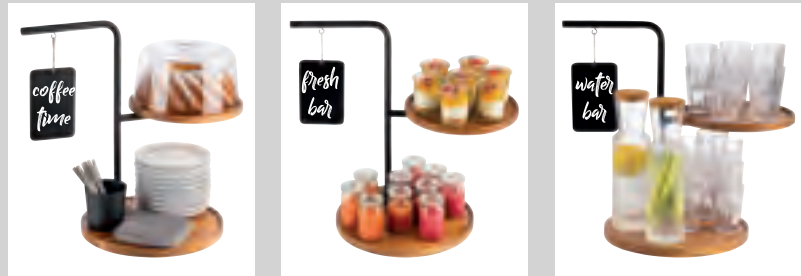

Präsentationsmöglichkeiten
presentation examples



2-stufige Etagère

2-tier tray
soporte 2 alturas
étagère 2 niveaux

1 Gestell aus schwarzem Metall, mit Antirutschfüßchen,
2 herausnehmbare Bretter aus geöltem Akazienholz (34,5 x 20,5 x 1,5 cm) / (34,5 x 13 x 1,5 cm)
8 Beschriftungsschilder (6 x 4 cm)

1 frame made of black metal with non-slip feet,
2 removable trays made of acacia wood (34,5 x 20,5 x 1,5 cm) / (34,5 x 13 x 1,5 cm)
8 labelling plates (6 x 4 cm)

1 soporte metálico, negro con pies antideslizantes,
2 bandejas extraíbles de madera de acacia (34,5 x 20,5 x 1,5 cm) / (34,5 x 13 x 1,5 cm)
8 etiquetas (6 x 4 cm)

1 support métallique noir avec pieds antidérapants,
2 planches amovibles en bois d'acacia (34,5 x 20,5 x 1,5 cm) / (34,5 x 13 x 1,5 cm)
8 étiquettes (6 x 4 cm)



	cm	↑ cm	€
30339	35,5 x 21	40	59,00



Präsentationsmöglichkeiten
presentation examples

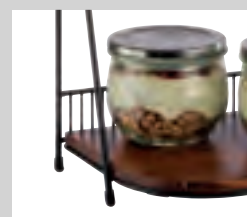

mit Antirutschfüßchen
with non-slip feet

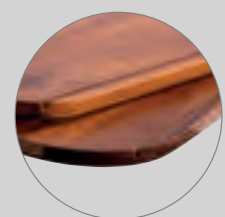

geöltes Akazienholz
oiled acacia wood



1 x Gestell / 1 x frame



2 x Korb / 2 x basket

5 tlg.
5 pcs.

2 x Tablett / 2 x tray



Haube / cover 11056



Korb / basket 30337



Tablett / tray 85099



Tablett / tray 30338

2-stufige Etagère „ALL-ROUNDER“, 5-teilig

2-tier tray, 5 pcs.

soporte 2 alturas, set de 5

étagère 2 niveaux, set de 5

5 teiliges Set:

- 1 Gestell aus schwarzen Metall, mit Antirutschfüßchen,
- 2 Körbe aus Metall schwarz je 29 x 16 cm, H: 7 cm,
- 2 herausnehmbare Bretter aus geöltem Akazienholz je 28,5 x 15,5 cm, H: 1,5 cm

5 pcs.:

- 1 frame made of black metal with non-slip feet,
- 2 baskets of black metal each 29 x 16 cm, H: 7 cm,
- 2 boards of oiled acacia wood each 28,5 x 15,5 cm, H: 1,5 cm

set de 5:

- 1 soporte metálico, negro con pies antideslizantes,
- 2 cestas metálicas negras, cada una de 29 x 16 cm, H: 7 cm,
- 2 tablas de madera de acacia aceiteada 28,5 x 15,5 cm, H: 1,5 cm

set de 5:

- 1 support métallique noir avec pieds antidérapants,
- 2 paniers métalliques noirs, chacune 29 x 16 cm, H: 7 cm,
- 2 planches d'acacia huilé, chacune 28,5 x 15,5 cm, H: 1,5 cm



	cm	↑ cm	€
30336	31 x 17	37,5	64,00

Präsentationsmöglichkeiten
presentation examplesgeöltes Akazienholz
oiled acacia woodmit Antirutschfüßchen
with non-slip feet

Korb / basket / cesta / corbeille

	cm	↑ cm	Farbe / Colour	€
30337	29 x 16	7	■	19,00

Servierbrett aus Akazienholz / serving board of acacia wood / tabla de servir de madera de acacia / planche de service en bois d'acacia

	cm	↑ cm	Farbe / Colour	€
30338	28,5 x 15,5	3,5	■	8,20

Melamintablett / melamine tray / bandeja de melamina / plateau en mélamine

	cm	↑ cm	Farbe / Colour	€
85099	28,0 x 15,5	1,0	■	13,60

Haube / cover / campana / cloche

	cm	↑ cm	€
11056	26,0 x 12,0	10,0	6,00

SERVING STANDS

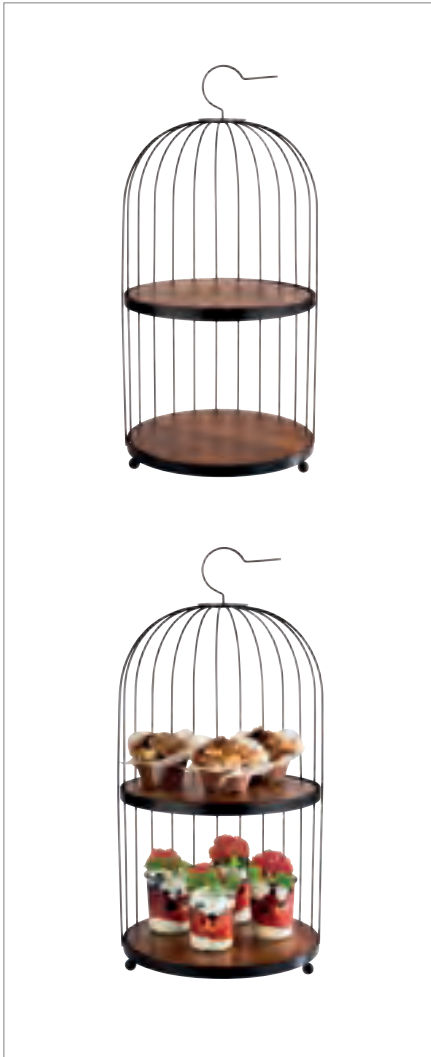

Buffetgestell „BIRDCAGE“

buffet stand
soporte para buffet
présentoir buffet



Gestell aus schwarzem Metall, inklusive 2 Akazienholzplatten

black metal frame, incl. 2 acacia wood panels
soporte metálico negro, con 2 tablas de madera de acacia
support métallique noir, avec 2 panneaux en bois d'acacia

	Ø cm	↑ cm	€
33206	26	54	55,00

Ersatz-Holzplatte

spare wooden panel
tabla de madera de recambio
panneau en bois de rechange

	Ø cm	↑ cm	€
33207	25	1	15,40



Brot- und Obstkorb

basket for bread or fruits
cesta para pan o fruta
corbeille à pain ou à fruits



inklusive Tasche aus Baumwolle, beige grau, maschinenwaschbar bis 30 Grad

incl. bag made of cotton, beige, grey, machine washable up to 30°C
bolsa incluida, de algodón, beige, gris, lavable a máquina hasta 30°C
sac inclus en coton, beige, gris, lavable en machine jusqu'à 30°C

	Ø cm	↑ cm	€
30209	27,5	18,5	32,00



stapelbar
stackable



rutschfest inklusive Klipp
non-slip, includes clip

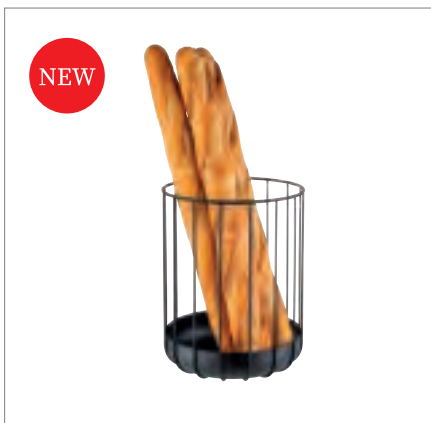

Brot- und Obstkorb „URBAN“

basket for bread or fruits
cesta para pan o fruta
corbeille à pain ou à fruits



Gestell aus schwarzem Metall

black metal frame
soporte metálico negro
support métallique noir

	Ø cm	↑ cm	€
30211	22,5	28	26,00

NEW

**Eierkorb „OVO“**

egg basket
cesta de huevos
panier à oeufs

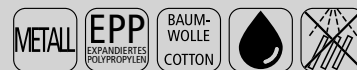

Gestell aus Metall, EPP-Box sorgt für perfekte Wärmeisolierung, Eier werden lange warm gehalten, inklusive waschbarem Stoffeinsatz

metal frame, EPP box ensures perfect heat insulation, Eggs are kept warm for a long time, including washable fabric insert
estructura de metal, la caja de EPP garantiza un perfecto aislamiento térmico, los huevos se mantienen calientes durante mucho tiempo, incluye inserto de tela lavable
structure en métal, la boîte EPP assure une isolation thermique parfaite, les oeufs sont maintenus au chaud pendant longtemps, insert en tissu lavable inclus

	Ø cm	↑ cm	€
30480	23	31	29,00

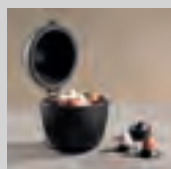
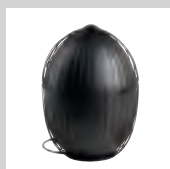

für ca. 35 Eier
for approx. 35 eggs



GN 1/3

GN 1/2

3 tlg.
3 pcs.**Serviergestell, 2-stufig**

servicing stand, 2-tier
soporte platos, 2 alturas
présentoir, 2 hauteurs



3 tlg. Set: 1 Gestell aus Akazienholz, 2 Schieferplatten

3 pcs.: 1 stand acacia wood, 2 slate trays

set de 3: 1 soporte madera de acacia, 2 bandejas de pizarra

set de 3: 1 présentoir en bois d'acacia, 2 plateaux en ardoise naturelle



zusammenklappbar
foldable

	cm	↑ cm	€
00958	36,5	34 x 26,5	38,80

**3-stufige Etagère**

3-tier tray
bandeja con tres alturas
étagère carré 3 hauteurs



Naturschieferplatte, Akazienholz

natural slate tray, wood akazie

bandeja de pizarra natural, madera de acacia

plateau ardoise naturelle, bois d'acacia

	Ø cm	↑ cm	* mm	€
00960	30 / 25 / 20	34	6 - 9	30,00

**2-stufige Etagère**

2-tier tray
bandeja dos alturas
étagère carré 2 hauteurs



Naturschiefer

natural slate tray

bandeja de pizarra natural

plateau ardoise naturelle

	Ø cm	↑ cm	* mm	€
00989	25 / 20	24	6 - 9	15,30

SERVING STANDS



Brezel- oder Wurstständer

pretzel- / sausage stand
soporte para pretzels/ embutidos
support à bretzel ou à saucissons



Verkaufsständer Buchenholz versiegelt, bestens geeignet für die Präsentation von Brezeln, Würstchen, etc., Fuß Ø 22 cm

beech wood, ideal to present pretzels, sausages, etc., base Ø 22 cm

soporte de madera de haya, ideal para presentar pretzels, salchicas, etc., base Ø 22 cm
support en bois de hêtre, pour la présentation de bretzels, saucisses, etc. pied Ø 22 cm

	Ø cm	↑ cm	€
79553	28	50	21,00

Hygieneschutz für Brezelständer / hygienic cover / campana higiénica antialiento / pare-haleine

	cm	↑ cm	€
11557	20 x 20 x 20	50	22,00
11558	15 x 20 x 15	50	20,00



Hobel für Käse und Schokolade

cheese / choco curler
rizador para queso y chocolate
frisette pour fromage et chocolat



3-teilig: Platte Buchenholz versiegelt Ø 22 cm mit senkrechtem Stift + Hobel 7 cm + Haube Ø 15 x 10 cm, für Käse und Schokolade

3 pcs.: wooden base Ø 22 cm with vertical bolt + plough 7 cm
+ cover Ø 15 x 10 cm, for cheese and chocolate

set de 3: base de madera Ø 22 cm, con eje vertical de 7 cm
+ campana Ø 15 x 10 cm, para „rizar“ queso y chocolate

set de 3: base bois Ø 22 cm, axe vertical ht. 7 cm, cloche Ø 15 x ht 10 cm,
pour „friser“ le fromage ou le chocolat

	Ø cm	↑ cm	€
50002	22	15	21,00

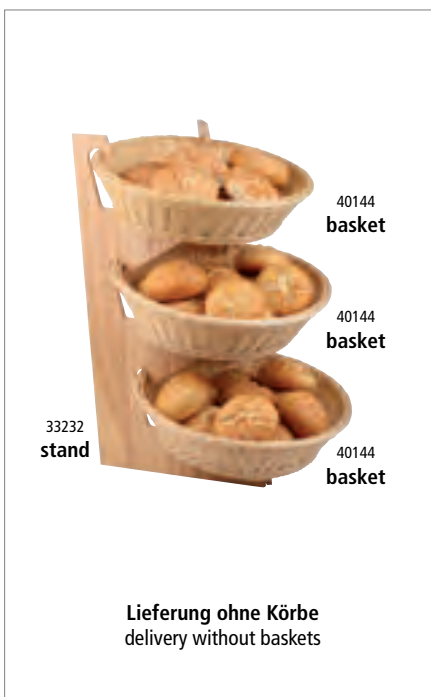

Buffetgestell

buffet stand
soporte para buffet
présentoir buffet



3-stufig, Rubberwood, geeignet für Körbe, platzsparend zusammenklappbar

3-tier, rubberwood, usable for baskets, can be pushed together for place saving

3 alturas, madera de caucho, apto para cestas, se puede plegar para ahorrar espacio

3 hauteurs, bois d'hévéa, pour corbeilles, la structure s'ouvre ou se ferme pour réduire l'encombrement

	cm	↑ cm	€
33232	59 x 30,5	59	22,00

Tisch- und Buffetkorb, rund „ECONOMIC“ / buffet basket, round / cesta de buffet redonda / corbeille de buffet ronde

	Ø cm	↑ cm	€
40144	39,0	10,0	19,00

**Buffetständer „ACACIA“**

buffet stand
soporte para buffet
présentoir buffet

Akazienholz geölt / acacia wood oiled / madera de acacia aceitada / bois d'acacia huilé



	Ø cm	↑ cm		€
15620	20,0	10,5		31,00
15621	30,5	15,0		53,00
15622	30,5	20,0		58,00

Frischhaltehaube / cover / campana / cloche

	Ø cm	↑ cm	fits to	€
06520	30	22	15621, 15622	37,00

Frischhaltehaube / cover / campana / cloche

	Ø cm	↑ cm	fits to	€
06512	30	11,5	15621, 15622	8,20

**Buffetständer „ACACIA“**

buffet stand
soporte para buffet
présentoir buffet

Akazienholz geölt / acacia wood oiled / madera de acacia aceitada / bois d'acacia huilé



	cm	↑ cm	GN	€
15623	53 x 16,2	20	2/4	63,00

**GN Abdeckhaube / GN cover / GN campana/ GN cloche**

	cm	↑ cm	GN	€
11044	53 x 16,2	10,5	2/4	23,00



CUTTING BOARDS



Brottschneidebrett „PROFI“

cutting board
tabla de cortar
planche à découper

Eichenholz / oak wood / mader de roble / bois de chêne



	cm	↑ cm		€
00806	58 x 37,5	4		118,00

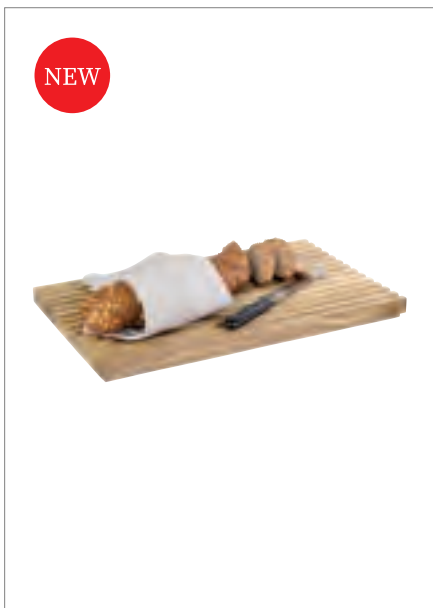

NEW

Brottschneidebrett „VALO“

cutting board
tabla de cortar
planche à découper

Eichenholz (geölt), mit Antirutsch-Füßchen

oak wood (oiled), with non-slip feet
mader de roble (acweitada), con pies antideslizantes
bois de chêne (huilé), avec pieds antidérapants



	cm	↑ cm	GN	€
00764	53 x 32,5	3,5	1/1	100,00

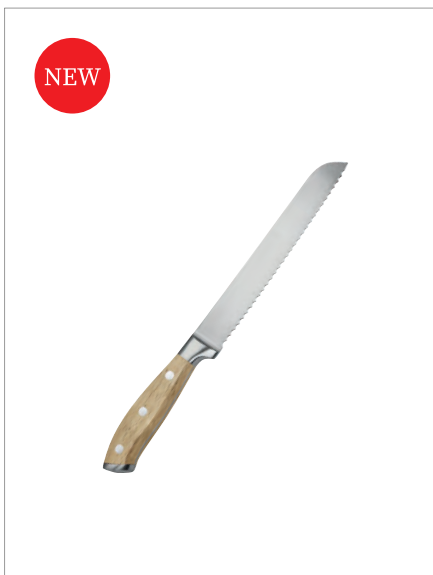

NEW

Brotmesser

bread knife
cuchillo para pan
couteau à pain

Brotmesser aus rostfreiem Edelstahl, dreifach genietet, mit Griff aus Buchenholz

bread knife made of stainless steel, triple riveted, with beech wood handle
cuchillo para pan de acero inoxidable, triple remachado, con mango de mader de haya
couteau à pain en acier inox, triplement riveté, avec manche en bois de hêtre



	→ cm	€
88990	34	16,00

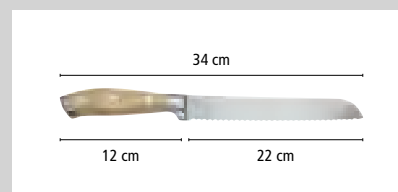



Brotschneidebrett

cutting board
tabla de cortar
planche à découper

Walnussholz / walnut wood / madera de nogal / bois de noyer



	cm	↑ cm	GN	€
00911	35,4 x 32,5	3,5	2/3	77,00



praktisches Krümelfach
practical crump shelf



Brotschneidebrett „LETTER“

cutting board
tabla de cortar
planche à découper

Akazienholz / acacia wood / madera de acacia / bois d'acacia



	cm	↑ cm	GN	€
00886	48 x 34	3,5		34,00



praktisches Krümelfach
practical crump shelf



Brotschneidebrett

cutting board
tabla de cortar
planche à découper

Akazienholz / acacia wood / madera de acacia / bois d'acacia



	cm	↑ cm	GN	€
00883	47,5 x 32,0	2		30,00
00884	53,0 x 32,5	2	1/1	31,00
00885	60,0 x 40,0	2		36,00



praktisches Krümelfach
practical crump shelf



Brotschneidebrett

cutting board
tabla de cortar
planche à découper

Rubberwood / rubberwood / madera de caucho / bois d'hévéa



	cm	↑ cm	GN	€
00955	47,5 x 32,0	2		27,00
00956	53,0 x 32,5	2	1/1	29,00
00957	60,0 x 40,0	2		34,00



praktisches Krümelfach
practical crump shelf

CUTTING BOARDS



00954
Box

00953
Schneidebrett

83615
Tablett



Tablett „BROTSTATION“

tray
bandeja
plateau

mit Antirutschfüßchen
with non-slip feet
con pies antideslizantes
avec pieds antidérapants



	cm	↑ cm	€
83615	59,5 x 35,5	3,5	42,00

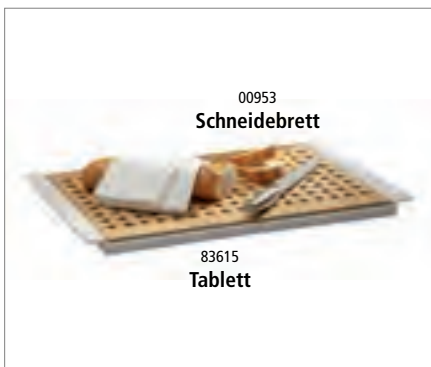

00953
Schneidebrett

83615
Tablett

Brotschneidebrett „BROTSTATION“

cutting board
tabla de corte
planche à découper

Buchenholz
beech
haya
hêtre



	cm	↑ cm	€
00953	52 x 34	2	37,00

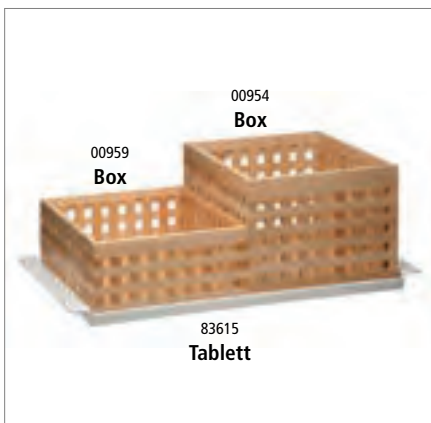

00959
Box

83615
Tablett

Box „BROTSTATION“

box
caja de pan
boîte à pain

Buchenholz
beech
haya
hêtre



	cm	↑ cm	€
00959	34 x 26	12,5	52,00
00954	34 x 26	20,0	64,00



Schneidebrett

cutting board
tabla de cortar
planche à découper

Eichenholz, geölt, mit Antirutsch-Füßchen

oak wood oiled, with non-slip feet
madera de roble aceitada, con pies antideslizantes
bois de chêne huilé, avec pieds antidérapants



	cm	↑ cm	Farbe / Colour	€
00762	58,5 x 35	2		72,00



Präsentationsmöglichkeit 2-teilig
presentation example 2-piece

Eichenholz
oak wood



Schneidebrett

cutting board
tabla de cortar
planche à découper

Walnuss, geölt, mit Antirutsch-Füßchen

walnut wood oiled, with non-slip feet
madera de nogal aceitada, con pies antideslizantes
bois noyer huilé, avec pieds antidérapants



	cm	↑ cm	Farbe / Colour	€
00763	58,5 x 35	2		90,00

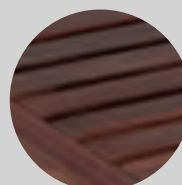

Präsentationsmöglichkeit 2-teilig
presentation example 2-piece

Walnuss
walnut wood



Tablett / Basis

tray / base
bandeja / base
plateaux / base

Melamin, schwarz, mit Antirutsch-Füßchen, passendes Schneidebrett Nr. 762, 763

melamine, black, with non-slip feet, suitable cutting board art. 762, 763
melamina, negro, con pies antideslizantes, tabla de cortar adecuada art. 762, 763
mélamine, noir, avec pieds antidérapants, planche à découper appropriées art. 762, 763



	cm	↑ cm	€
85225	67 x 38	4	78,00

SQUARE



GN 1/1 Buffetbrett „SQUARE“

GN 1/1 buffet board
GN 1/1 tabla de buffet
GN 1/1 planche de buffet

aus geöltem Eichenholz
made of oiled oak wood
de madera de roble aceitada
en bois de chêne huilé



	cm	↑ cm	GN	€
00758	53,0 x 32,5	2,5	1/1	43,00

passende Haube / suitable cover / campana adecuada / cloche appropriée

	cm	↑ cm	GN	€
11075	53,0 x 32,5	19	1/1	62,00



Haube fixiert sich auf dem Brett, rutschfest
cover fixes itself on the board, non-slip



GN 1/2 Buffetbrett „SQUARE“

GN 1/2 buffet board
GN 1/2 tabla de buffet
GN 1/2 planche de buffet

aus geöltem Eichenholz
made of oiled oak wood
de madera de roble aceitada
en bois de chêne huilé



	cm	↑ cm	GN	€
00759	32,5 x 26,5	2,5	1/2	28,00

passende Haube / suitable cover / campana adecuada / cloche appropriée

	cm	↑ cm	GN	€
11073	33 x 28	17	1/2	29,00



Haube fixiert sich auf dem Brett, rutschfest
cover fixes itself on the board, non-slip



GN 2/4 Buffetbrett „SQUARE“

GN 2/4 buffet board
GN 2/4 tabla de buffet
GN 2/4 planche de buffet

aus geöltem Eichenholz
made of oiled oak wood
de madera de roble aceitada
en bois de chêne huilé



	cm	↑ cm	GN	€
00760	53,0 x 16,2	2,5	2/4	28,00



Präsentationsmöglichkeit
presentation example

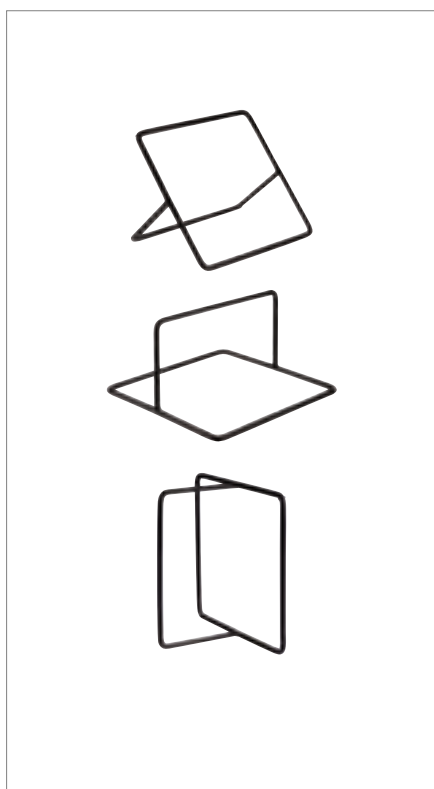

Buffetständer „SQUARE“

buffet stand
soporte para buffet
présentoir buffet

Metall, mit schwarzer Antirutschbeschichtung
metal, with black anti-slide coating
metal, con revestimiento antideslizante negro
métal, avec revêtement antidérapant noir



	cm	↑ cm	€
33305	12 x 12	7	6,50



Präsentationsmöglichkeit 2-teilig
presentation example 2-piece



GN Rolltophaube

GN rolltop cover
GN campana rolltop
GN cloche rolltop

patentiert, passend für GN-Behälter, -Tablets, etc., leichtgängig auf- und zuklappbar 90°
patented, suitable for GN containers, GN trays, etc. 90° opening
patentada, para cubetas GN, bandejas GN, etc. fácil de abrir y cerrar 90°
brevetée, pour bacs GN, plateaux GN, etc. s'ouvre et se ferme facilement à 90°



	cm	↑ cm	GN	€
11060	53,0 x 32,5	19	1/1	64,00
11061	32,5 x 26,5	15	1/2	59,00



Designgriff
design handle

BUFFET BOARDS „PROFI“



Buffetbrett „PROFI“ buffet board tabla de buffet planche de buffet

aus geöltem Eichenholz, Safrinne, mit Antirutschfüßchen

made of oiled oak, with juice groove and non-slip feet

de madera de roble aceitada, con ranura para líquidos y pies antideslizantes

en bois chêne huilé, avec rigole et pieds antidérapants



	Ø cm	↑ cm		€
00805	33	4,5		73,00
00816	39	4,5		118,00

Frischhaltehaube / cover / campana / cloche



	Ø cm	↑ cm	fits to	€
06512	30	11,5	00805	8,20

Frischhaltehaube / cover / campana / cloche



	Ø cm	↑ cm	fits to	€
06520	30	22	00805	37,00
06521	36	27	00816	74,00



Buffetbrett „PROFI“ buffet board tabla de buffet planche de buffet

aus geöltem Eichenholz, Safrinne, mit Antirutschfüßchen

made of oiled oak, with juice groove and non-slip feet

de madera de roble aceitada, con ranura para líquidos y pies antideslizantes

en bois chêne huilé, avec rigole et pieds antidérapants



	cm	↑ cm		€
00807	38 x 32,0	4,5		78,00
00806	58 x 37,5	4,5		118,00

Rolltophaube / rolltop cover / campana rolltop / cloche rolltop



	Ø cm	↑ cm	fits to	GN	€
11016	53,0 x 32,5	19	00806	1/1	64,00

MODULO



Buffet Box „MODULO“

buffet box
caja buffet
boîte à buffet



Eichenholz, geölt, Innenmaße: 15,5 x 10 cm
oak wood oiled, interior dimensions: 15,5 x 10 cm
madera de roble aceitada, medidas int.: 15,5 x 10 cm
bois de chêne huilé, dimensions int.: 15,5 x 10 cm

	cm	↑ cm	€
11728	17,5 x 15,5	12,5	28,00



stapelbar
stackable



Präsentationsmöglichkeit
presentation example



Buffet Box „MODULO“

buffet box
caja buffet
boîte à buffet

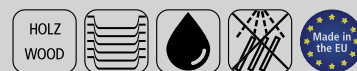

aus geöltem Eichenholz, 2 Fächer je: 25 x 16 cm, mit 2 Griffmulden
made of oiled oak wood, 2 compartments: each 25 x 16 cm, with 2 recessed grips
de madera de roble aceitada, 2 compartimentos de 25 x 16 cm, con 2 asas empotradas
en bois de chêne huilé, 2 compartiments: chacun 25 x 16cm, avec 2 poignées encastrées

	cm	↑ cm	€
11729	35 x 31	12,5	58,00



stapelbar
stackable



Präsentationsmöglichkeit
presentation example

NAPKIN HOLDERS

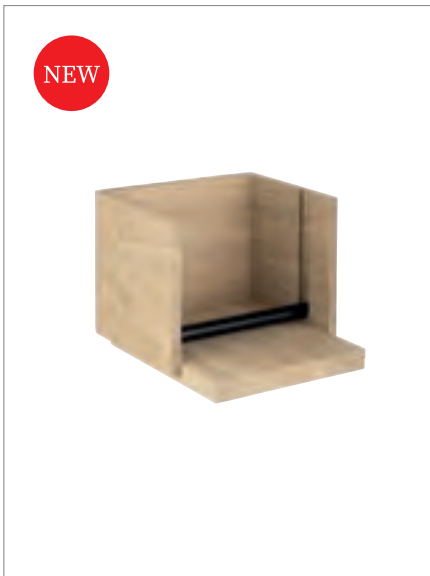

Serviettenhalter „VALO“

napkin holder
servilletero
porte-serviettes



Eichenholz (geölt), für ca. 100 Servietten mit 1/4 Falz, inklusive Beschwerer

oak wood (oiled), for approx. 100 napkins with 1/4 fold, including weight

madera de roble (aceitada), para aprox. 100 servilletas con 1/4 de pliegue, con barra de contrapeso

bois du chêne (huilé), pour env. 100 serviettes pliées en 1/4, avec barre de contrepois

	cm	↑ cm	€
14092	19 x 19	16	59,00



stapelbar
stackable



Table Caddy „VALO“

table caddy
caddy de mesa
caddy de table



Eichenholz (geölt), 3 Fächer, mit Antirutsch-Füßchen

oak wood (oiled), 3 compartments, with non-slip feet

madera de roble (aceitada), 3 compartimentos, con pies antideslizantes

bois de chêne (huilé), 3 compartiments, avec pieds antidérapants

	cm	↑ cm	€
14090	15 x 15	28	66,00



Table Caddy „VALO“

table caddy
caddy de mesa
caddy de table



Eichenholz (geölt), 3 Fächer, mit Antirutsch-Füßchen

oak wood (oiled), 3 compartments, with non-slip feet

madera de roble (aceitada), 3 compartimentos, con pies antideslizantes

bois de chêne (huilé), 3 compartiments, avec pieds antidérapants

	cm	↑ cm	€
14091	15 x 15	31	89,00

CUTLERY BOXES



Besteckbehälter

cutlery box
recipiente para cubiertos
réceptif pour couverts

Akazienholz, 4 Fächer (26 x 11,5 cm)

acacia wood, 4 compartments (26 x 11,5 cm)

madera de acacia, 4 compartimentos (26 x 11,5 cm)

bois d'acacia, 4 compartiments (26 x 11,5 cm)



	cm	↑ cm	Farbe / Colour		€
11952	51 x 28	13		nature	53,00
11951	51 x 28	13		vintage white	53,00



Besteckbehälter mit Deckel

cutlery box with cover
caja de cubiertos con tapa
range-couverts avec couvercle

Akazienholz, 4 Fächer (26 x 11,5 cm), mit Deckel

acacia wood, 4 compartments (26 x 11,5 cm), with cover

madera de acacia, 4 compartimentos (26 x 11,5 cm), con tapa

bois d'acacia, 4 compartiments (26 x 11,5 cm), avec couvercle



	cm	↑ cm	Farbe / Colour		€
11949	51 x 28	14,5		nature	78,00
11948	51 x 28	14,5		vintage white	78,00



GN 1/1 Besteckbehälter

GN 1/1 dispenser GN
GN 1/1 dispensador de cubiertos
GN 1/1 bac à couverts

in Handarbeit geflochten, 4 Mulden, Kunststoff-Geflecht, Drahtgestell, braun-schwarz

hand-woven, 4 troughs, plastic wickerwork, wire frame, brown-black

cesta trensada a mano, 4 compartimentos, mimbre de plástico, marco de alambre, marrón-negro

corbeille tressée à main, 4 compartiments, plastique tressé, armature en fil métallique, brun-noir



	cm	↑ cm	Farbe / Colour	GN	€
11966	53 x 32,5	9		1/1	43,00



GN 1/1 Besteckbehälter

GN 1/1 cutlery dispenser
GN 1/1 dispensador de cubiertos
GN 1/1 bac à couverts

4 Mulden, Kunststoff-Geflecht, Drahtgestell, beige

4 troughs, plastic wickerwork, wire frame, beige

4 compartimentos, mimbre de plástico, marco de alambre, beige

4 compartiments, plastique tressé, structure métallique, beige



	cm	↑ cm	Farbe / Colour	GN	€
11965	53 x 32,5	10		1/1	30,00

**Besteckbehälter**

cutlery basket
recipiente para cubiertos
récipients pour couverts

4 Löcher inklusive 4 Edelstahl Köcher

4 holes including 4 stainless baskets

4 agujeros con 4 cestas de acero inoxidable

4 trous avec 4 corbeilles en acier inox



	cm	↑ cm	€
93321	27 x 27	15	84,00

**Besteckköcher**

cutlery basket
cesta para cubiertos
corbeille à couverts

matt poliert / matt polished / pulido mate / poli mat



	Ø cm	↑ cm	€
11999	9,5	13,5	8,00

**Besteckköcher**

cutlery basket
cesta para cubiertos
corbeille à couverts



	Ø cm	↑ cm	€
11998	9,5	13,5	2,90

**Besteckkasten „INDUSTRIAL“**

cutlery box
caja para cubiertos
boîte pour couverts



	cm	↑ cm	ltr.	€
40676	23,0 x 15,5	13,0	2,4	15,20



Buffetständer „WOOD“

buffet stand
soporte para buffet
présentoire buffet



Akazienholz, liegend oder stehend, variable Nutzungsmöglichkeiten

acacia wood, usable by lying or standing, variable usage possibilities
madera de acacia, se puede usar tumbado o de pie, opciones de uso variable
bois d'acacia, possibilités d'utilisation variables

	cm	↑ cm	Farbe / Colour	€
33280	20 x 20	17,5		12,40
33281	20 x 20	17,5		12,40



liegend oder stehend, variable Nutzungsmöglichkeiten
vertically or horizontally, variable usage possibilities



Buffetständer

buffet stand
expositor de buffet
présentoir buffet



Akazienholz
acacia wood
madera de acacia
bois d'acacia

	Ø cm	↑ cm	€
33255	15	10	18,00
33256	25	15	22,00

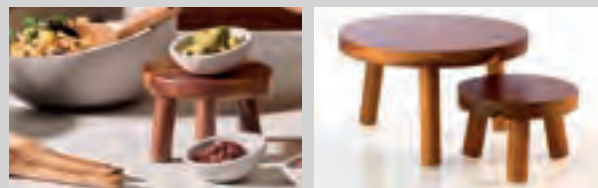

Präsentationsmöglichkeit
presentation example

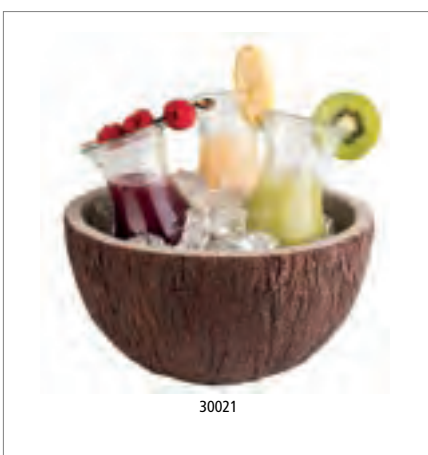

Schale „COCONUT“

bowl
cuenco
bol



	Ø cm	↑ cm	litr.	€
30020	18	9,5	1,0	22,80
30021	23	12,5	2,2	30,00

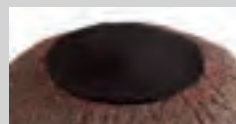

möbelschonende Unterseite
furniture-friendly underside

MANGO



Schale
bowl
cuenco
bol



Mangoholz, Epoxidharz, Motiv (innen): starry sky
mango wood, epoxy resin, design (inside): starry sky
madera de mango, resina epoxi, diseño (interior): starry sky
bois de manguiier, résine époxy, design (intérieur): starry sky

	Ø cm	↑ cm	ltr.	€
01050	20	7,5	0,8	19,00
01053	24	7,5	1,1	22,00
01056	30	10,5	3,0	32,00
01057	37	9,0	4,0	32,00



handgefertigt
handmade

**Tablett / Teller**

tray / plate
bandeja / plato
plateau / assiette



Mangoholz, Epoxidharz, Motiv (innen): starry sky

mango wood, epoxy resin, design (inside): starry sky

madera de mango, resina epoxi, diseño (interior): starry sky

bois de manguier, résine époxy, design (intérieur): starry sky

	Ø cm	↑ cm	€
01058	35,5	2,5	30,00

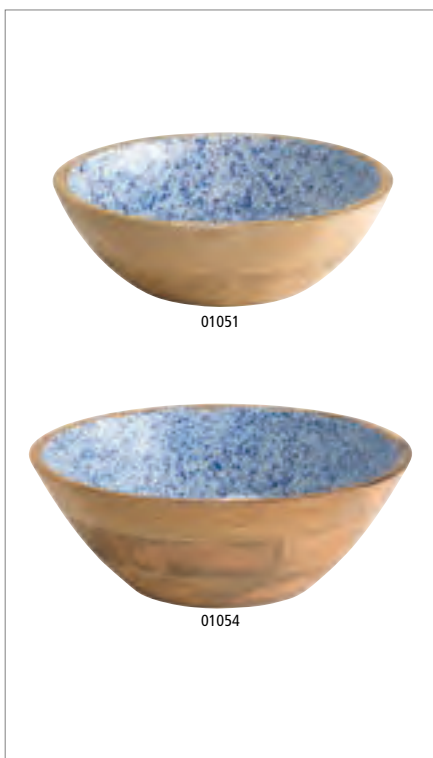
**Schale**

bowl
cuenco
bol



Mangoholz, Epoxidharz, Motiv (innen): weiß+blau

mango wood, epoxy resin, design (inside): white+blue

madera de mango, resina epoxi, diseño (interior): blanco+azul

bois de manguier, résine époxy, design (intérieur): blanc+bleu

	Ø cm	↑ cm	ltr.	€
01051	24	7,5	1,1	22,00
01054	30	10,5	3,0	32,00



handgefertigt
handmade



BEVERAGE DISPENSERS



Getränkespender „VALO“
 beverage dispenser
 dispensador de bebidas
 distributeur de boissons

GLAS
GLASS

HOLZ
WOOD

EDELSTAHL
STAINLESS
INOX

original
APS
melamine



**Eichenholz (wasserfest lackiert), Zapfhahn aus Edelstahl,
 Untersetzer aus Melamin, Bodenplatte (Gläserblett) herausnehmbar**

oak wood (waterproof lacquered), stainless steel tap,
 melamine coaster, removeable base plate

madera de roble (lacado impermeable), grifo de acero inoxidable,
 posavasos de melamina, placa base extraíble

bois de chêne (vernis imperméable), robinet en acier inox,
 dessous de verre en mélamine, plaque de fond amovible

	cm	↑ cm	ltr.	€
14025 <small>NEW</small>	18,0 x 18	41,0	3,8	200,00
14015	21,0 x 21	46,5	7	240,00
14016	43,5 x 21	46,5	2 x 7	390,00

TRAYS



Tablett mit Haube, 2 teilig

tray with cover, 2 pcs.
bandeja con campana, set de 2
plateau avec cloche, set de 2

Tablett aus Bambus, ölimprägniert + Haube

bamboo tray, oil-impregnated + cover
bandeja de bambú, impregnada de aceite + campana
plateau en bambou, imprégné d'huile + cloche



	Ø cm	↑ cm	€
00822	20,5	10	8,60



Tablett mit Haube, 2-teilig

tray with cover, 2 pcs.
bandeja con campana, set de 2
plateau avec cloche, set de 2

Tablett aus Bambus, ölimprägniert + Haube

bamboo tray, oil-impregnated + cover
bandeja de bambú, impregnada de aceite + campana
plateau en bambou, imprégné d'huile + cloche



	Ø cm	↑ cm	€
00825	25	13,5	11,00



Tablett mit Haube, 2-teilig

tray with cover, 2 pcs.
bandeja con campana, set de 2
plateau avec cloche, set de 2

Tablett aus Bambus, ölimprägniert + Haube

bamboo tray, oil-impregnated + cover
bandeja de bambú, impregnada de aceite + campana
plateau en bambou, imprégné d'huile + cloche



	cm	↑ cm	€
00826	28 x 14	11,5	9,80



Tablett mit Haube, 2 teilig

tray with cover, 2 pcs.
bandeja con campana, set de 2
plateau avec cloche, set de 2

Tablett aus Bambus, ölimprägniert + Haube

bamboo tray, oil-impregnated + cover
bandeja de bambú, impregnada de aceite + campana
plateau en bambou, imprégné d'huile + cloche



	cm	↑ cm	€
00820	24 x 18,5	8	7,40
00821	32 x 16,5	11	9,80

CAKE STANDS



Servier- und Tortenplatte „ACACIA“
 cake stand
 porta pasteles
 présentoir à gâteaux



Akazienholz geölt, möbelschonende Unterseite
 acacia wood oiled, furniture-friendly underside
 madera de acacia aceitada, con base anti rayaduras
 bois d'acacia huilé, avec revêtement antirayures

	∅ cm	↑ cm	€
33292	24,0	8	53,00
33293	24,0	16	68,00
33294	33,0	8	74,00
33295	33,0	16	100,00
33296	38,5	8	90,00
33297	38,5	16	116,00

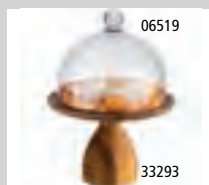

Frischhaltehaube „DOME“ / cover / campana / cloche



	∅ cm	↑ cm	fits to	€
06519	21	17	33292, 33293	30,00
06520	30	22	33294, 33295	37,00
06521	36	27	33296, 33297	74,00

ACACIA



00794 1,8 ltr.



00795 2,5 ltr.



00796 3,0 ltr.

Schale „ACACIA“

bowl
cuenco
bol

aus geöltem Akazienholz
made of oiled acacia wood
de madera de acacia aceitada
en bois d'acacia huilé



	Ø cm	↑ cm	ltr.	€
00794	21	8,5	1,8	38,00
00795	25	8,5	2,5	43,00
00796	27	8,5	3,0	48,00



3 Größen ineinander
3 sizes in each other



33269

Buffetständer „MULTI ROUND“

buffet stand
soporte para buffet
présentoir buffet

Metall, mit schwarzer Antirutschbeschichtung
metal, with black anti-slide coating
metal, con revestimiento antideslizante negro
métal, avec revêtement antidérapant noir



	Ø cm	↑ cm	€
33269	15,5 / 18	8	10,90
33270	15,5 / 18	10	13,00
33271	15,5 / 18	18	16,70

SIMPLY WOOD



Servierbrett „SIMPLY WOOD“

serving board
tabla de servir
planche de service



Eichenholz geölt, mit Aufhängeloch Ø 1,5 cm, mit Lederband

oak wood oiled, with handle hole Ø 1,5 cm, with leather strap
madera de roble aceitada, con agujero para colgar Ø 1,5 cm, con correa de cuero
bois de chêne huilé, avec trou de suspension Ø 1,5 cm, avec ruban en cuir

	cm	↑ cm	→ Griff / handle	€
00751	27 x 17	2	8	32,00
00752	32 x 22	2	8	42,00



mit Lederband
with leather strap



Tablett / Sushiboard „SIMPLY WOOD“

tray / sushiboard
bandeja para sushi
plateau sushi

aus geöltem Eichenholz
made of oiled oak wood
de madera de roble aceitada
en bois de chêne huilé



	cm	↑ cm	€
00753	35 x 17	2	23,80

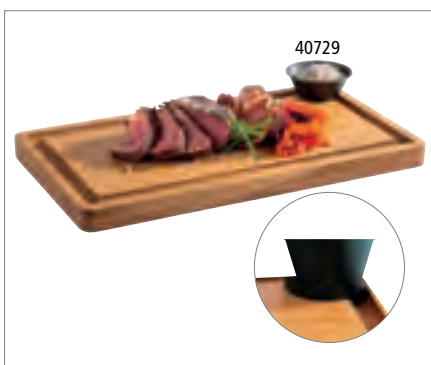

GN 1/3 Servierbrett „SIMPLY WOOD“

GN 1/3 serving board
GN 1/3 tabla de servir
GN 1/3 planche de service

Eichenholz geölt, mit Aussparung Ø 4 cm, mit Safrinne

oak wood oiled, with notch Ø 4 cm, with juice groove
madera de roble aceitada, con ranura Ø 4 cm, con ranura para líquidos
bois de chêne huilé, mit avec encoche Ø 4 cm, avec rigole



	cm	↑ cm	GN	€
00754	32,5 x 17,6	2	1/3	23,80

**Serviertablett „VALO“**

tray
bandeja
plateau

Eichenholz (geölt), Innenmaß 56 x 36 cm

oak wood (oiled), inside dimensions 56 x 36 cm

madera de roble (aceitada), dimensiones interiores 56 x 36 cm

bois du chêne (huilé), dimensions intérieures 56 x 36 cm



	cm	↑ cm	fits to	€
14060	60 x 40	3	14061	82,00

**Tablettständer „VALO“**

tray stand
soporte para bandejas
support de plateau

Eichenholz (geölt), zusammenklappbar

oak wood (oiled), collapsible

madera de roble (aceitada), plegable

bois du chêne (huilé), pliable

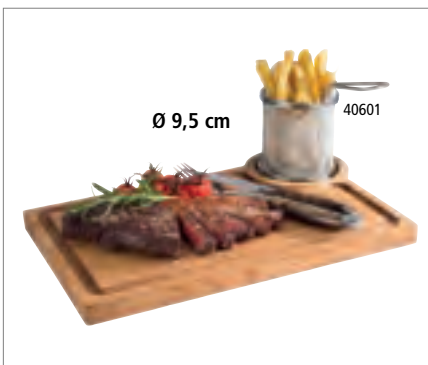

	cm	↑ cm	fits to	€
14061	56 x 35,5	75	14060	130,00

**Servierbrett „OAK“**

servicing board
tabla de servir
planche de service

aus geöltem Eichenholz, Safrille, Ø 9,5 cm Aussparung

made of oiled oak, with juice groove, with hole Ø 9.5 cm

de madera de roble aceitada, con ranura para líquidos, con agujero Ø 9,5 cm

en bois chêne huilé, avec rigole, avec trou Ø 9,5 cm



	cm	↑ cm	€
00808	37 x 25	2	31,00

**Servierbrett „PIZZA“**

servicing board
tabla de servir
planche de service

Eichenholz geölt, mit Safrinne, mit 2 Griffmulden

oak wood oiled, with juice groove, with 2 recessed handles

madera de roble aceitada, con ranura para líquidos, con 2 asas empotradas

bois de chêne huilé, avec rigole, avec 2 poignées encastrées



	Ø cm	↑ cm	€
00757	34	2	32,00

**Serviertablett**

servicing tray
bandeja para servir
plateau de service

aus geöltem Eichenholz, mit 2 Griffmulden

made of oiled oak wood, with 2 recessed handles

de madera de roble aceitada, con 2 asas empotradas

en bois de chêne huilé, avec 2 poignées encastrées



	cm	↑ cm	€
00761	45 x 35	6	48,00



SERVING BOARDS



Servierbrett „VELVET“

serving board
tabla de servir
planche de service

Servierbrett aus geöltem Akazienholz

serving board made of oiled acacia wood

tabla de servir de madera de acacia aceitada

planche en bois avec plateau en bois d'acacia huilé



	cm	↑ cm	€
00897	30 x 15	2	14,20
00898	30 x 18	2	16,50
00899	35 x 25	2	23,00



Servierbrett

serving board
tabla de servir
planche de service

aus geöltem Akazienholz

made of oiled acacia wood

de madera de acacia aceitada

en bois d'acacia huilé



	cm	↑ cm	€
00793	25 x 17	1,5	13,00



Servierbrett

serving board
tabla de servir
planche de service

aus geöltem Akazienholz

made of oiled acacia wood

de madera de acacia aceitada

en bois d'acacia huilé



	cm	↑ cm	€
00792	37 x 8	2	10,80

2 tlg.
2 pcs.

Servierbrett „FUSIONA“

serving board
tabla de servir
planche de service



2-teilig: 1 Holzbrett aus Akazienholz + 1 Naturschieferplatte

2 pcs.: 1 wood board made of acacia wood + 1 natural slate tray

set de 2: 1 tabla de madera de acacia + 1 pizarra natural

set de 2: 1 planche en bois d'acacia + 1 ardoise naturelle

	cm	↑ cm	€
00814	28 x 17,5	2	16,00

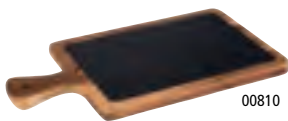

mit Aussparung ø 5 cm
with hole ø 5 cm

2 tlg.
2 pcs.

00810



00811



00812



00813

Servierbrett „FUSIONA“

serving board
tabla de servir
planche de service



2-teilig: 1 Holzbrett aus Akazienholz + 1 Naturschieferplatte

2 pcs.: 1 wood board made of acacia wood + 1 natural slate tray

set de 2: 1 tabla de madera de acacia + 1 pizarra natural

set de 2: 1 planche en bois d'acacia + 1 ardoise naturelle

	cm	↑ cm	Griff / handle cm	€
00810	26 x 18	2	8	15,00
00811	33 x 20	2	8	18,40
00812	40 x 15	2	5	23,40
00813	43 x 12	2	12	19,00

Präsentationsmöglichkeit
presentation example



00813

mit Hängeloch Ø 2 cm / with a handle-hole Ø 2 cm

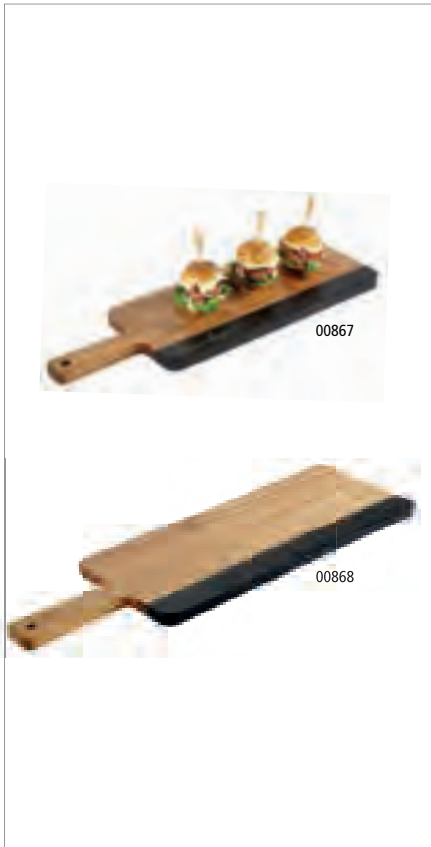

Servierbrett „ROCKWOOD“

serving board
 tabla de servir
 planche de service



geeignet zur Beschriftung, mit Hängeloch Ø 1 cm

suitable for labeling, with hanging hole Ø 1 cm

apto para rotulación, con orificio para colgar Ø 1 cm

adapté pour l'étiquetage, avec trou de suspension Ø 1 cm

	cm	↑ cm	Griff / handle cm	€
00867	30,5 x 13	1,5	10	18,60
00868	36,5 x 15	1,5	12	23,60
00869	42,0 x 18	1,5	14	26,80



Kreide-Marker, Stärke 2 mm, 2er Set

chalk marker, 2 pcs.

rotulador de tiza, set de 2

marqueur a la craie liquide, set de 2



Zum Gestalten und Beschriften von Tafeln, Glas und fast allen geschlossenen Oberflächen, deckende Flüssigkreide auf Wasserbasis, feucht abwischbar

For decorating and writing on boards, glass and almost all non-porous surfaces, opaque water-based liquid chalk, wet-wipeable

Rotuladores para pizarra de tiza líquida para decorar y escribir sobre pizarras, cristales y casi todas las superficies no porosas. Tiza líquida opaca al agua que se pueda borrar con un trapo

Pour décorations et inscriptions sur tableaux, verre et presque toutes les surfaces non poreuses, craie liquide opaque à base d'eau, effaçable avec un chiffon humide

	Ø cm	↑ cm	Farbe / Colour	pcs.	€ / set
71490	1	13	White	2	6,20



Servierbrett „SHARING“

serving board
 tabla de servir
 planche de service



Servierbrett aus geöltem Akazienholz

serving board made of oiled acacia wood

tabla de servir de madera de acacia aceitada

planche en bois d'acacia huilé

	cm	↑ cm	Griff / handle cm	€
00887	51,5 x 18	1,5	8,5	34,00



00905



00906

Servierbrett „OLIVE“

serving board
tabla de servir
planche de service



aus geöltem Olivenholz, naturbedingte Abweichung in Form, Maserung und Größe

oiled olive wood, natural deviation in shape, grain and size
de madera de olivo aceitada, diferencias naturales posibles en forma, grano y tamaño

en bois d'olivier huilé, éventuelles différences naturelles de forme, de grain et de taille

	cm	↑ cm	€
00905	25,5 x 16,5	1,5	12,00
00906	35,0 x 20,5	1,5	22,00



00870



00871



00876



00877



00873



00874

Servierbrett „OLIVE“

serving board
tabla de servir en madera de olivo
planche de service en bois d'olivier



aus geöltem Olivenholz, naturbedingte Abweichung in Form, Maserung und Größe, mit Hängeloch Ø 2 cm

oiled olive wood, natural deviation in shape, grain and size, with hanging hole Ø 2 cm

de madera de olivo aceitada, diferencias naturales posibles en forma, grano y tamaño, con orificio para colgar Ø 2 cm

en bois d'olivier huilé, éventuelles différences naturelles de forme, de grain et de taille, avec trou de suspension Ø 2 cm

	cm	↑ cm	Griff / handle cm	€
00870	25 x 17,0	1,5		32,00
00871	30 x 20,5	2,0		52,00
00873	40 x 15,0	1,5	11	56,00
00874	44 x 20,0	2,0	12	72,00
00876	25 x 16,0	1,5	8	35,00
00877	31 x 20,0	1,5	9	52,00

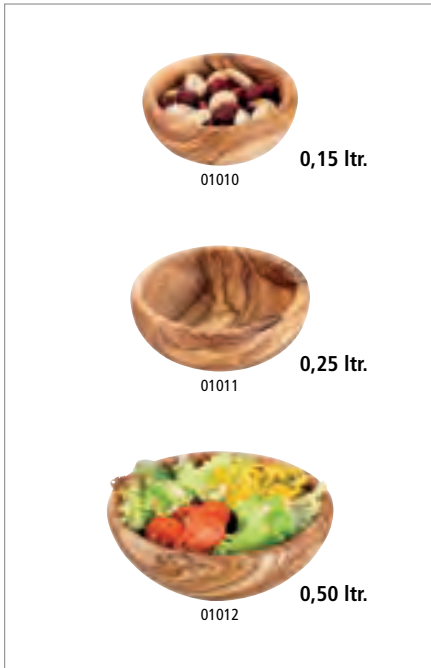

Schale „OLIVE“

bowl
cuenco
bol



aus geöltem Olivenholz, naturbedingte Abweichung in Form, Maserung und Größe

oiled olive wood, natural deviation in shape, grain and size

de madera de olivo aceitada, diferencias naturales posibles en forma, grano y tamaño

en bois d'olivier huilé, éventuelles différences naturelles de forme, de grain et de taille

	Ø cm	↑ cm	ltr.	€
01010	10,0	4,0	0,15	10,00
01011	12,5	4,5	0,25	13,80
01012	15,0	6,0	0,50	20,00



3 Größen ineinander
3 sizes in each other



Schale „OLIVE“

bowl
cuenco
bol



aus geöltem Olivenholz, naturbedingte Abweichung in Form, Maserung und Größe

oiled olive wood, natural deviation in shape, grain and size

de madera de olivo aceitada, diferencias naturales posibles en forma, grano y tamaño

en bois d'olivier huilé, éventuelles différences naturelles de forme, de grain et de taille

	cm	↑ cm	ltr.	€
00843	12,0 x 7,5	2,5	0,05	7,80
00844	16,5 x 9,5	2,5	0,10	10,00

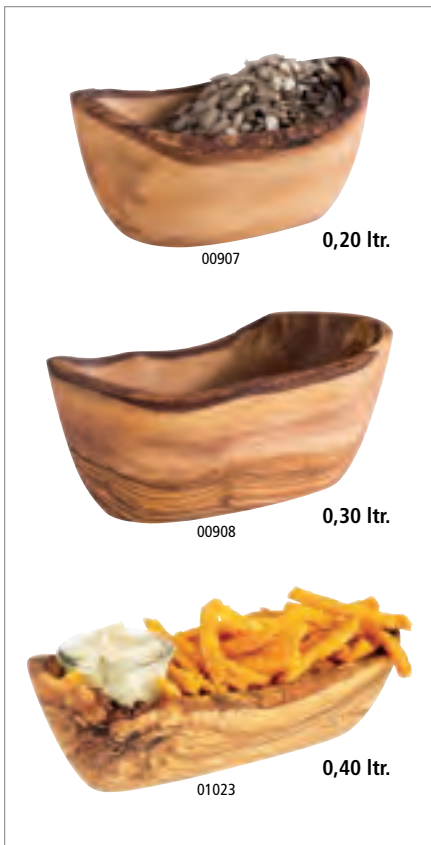

Schale „OLIVE“

bowl
cuenco
bol



aus geöltem Olivenholz, naturbedingte Abweichung in Form, Maserung und Größe

oiled olive wood, natural deviation in shape, grain and size

de madera de olivo aceitada, diferencias naturales posibles en forma, grano y tamaño

en bois d'olivier huilé, éventuelles différences naturelles de forme, de grain et de taille

	cm	↑ cm	ltr.	€
00907	13,0 x 8,0	6,5	0,2	6,60
00908	16,0 x 9,0	7,0	0,3	10,00
01023	25,0 x 8,5	7,5	0,4	18,00

**Table Caddy „OLIVE“**

table barrel
caddy de mesa
caddy de table

aus geöltem Olivenholz

oiled olive wood

de mader de olivo aceiteada

en bois d'olivier huilé



	cm	↑ cm	€
01016	22 x 15	6	21,00
01017	25 x 18	6	29,00



Allzweckstreuer, 12 er Set / shaker, 12 pcs. / dosificador, set de 12 / salières/poivrières set de 12

	cm	↑ cm	ltr.	€ / set
40504	4 x 4	10	0,07	23,40

passende Brottasche / suitable bread basket / panera a juego / corbeilla assortie

	cm	↑ cm	Farbe / Colour	€
30356	12 x 11,5	11,5	■	6,80

passende Mühlen / suitable mills/ molinos de ajuste / moulins assortis

	ø cm	↑ cm	€
40555	6	15,5	33,20
40556	6	15,5	33,20

**Wachspapier „SNACKHOLDER“**

greaseproof paper squares

papel alimenticio

papier alimentaire



	cm	pcs.	Motiv: Zeitung	€
40670	42 x 25	500	Motiv: Zeitung	59,00



Schale „OLIVE“

bowl
cuenco
bol

aus geöltem Olivenholz
oiled olive wood
de madera de olivo aceitada
en bois d'olivier huilé



	cm	↑ cm	ltr.	€
01013	7,5 x 7,5	2,5	0,05	5,00
01014	17,5 x 8,5	2,5	0,15	12,40
01015	26,5 x 11,5	5,0	0,60	19,00



Servierbeispiel - Lieferung ohne Gläser
delivery without glasses

Holzbox „TABLE“

woodbox
caja madera
base bois

Akazienholz, 3 Fächer (6,5 x 6,5 cm) / acacia wood, 3 compartments (6,5 x 6,5 cm) / madera de acacia, 3 compartimentos (6,5 x 6,5 cm) / bois d'acacia, 3 compartiments (6,5 x 6,5 cm)



	cm	↑ cm	inner size cm	€
11727	23,5 x 8,5	4,5	6,5 x 6,5 je Fach / each compartment	13,60



Servierbrett „NARROW I“

serving board
tabla de servir
planche de service

Akazienholz, mit 3 Vertiefungen Ø 4 cm / acacia wood, with 3 notches Ø 4 cm
madera de acacia, con 3 ranuras Ø 4 cm / bois d'acacia, avec 3 encoches Ø 4 cm



	cm	↑ cm	€
00864	22 x 8	1,5	10,60

passende Schälchen / fitting bowls / cuencos adecuados / bols appropriés

	Ø cm	↑ cm	ltr.	VE / unit	€ / pc.	
40685	6	3,0	0,05	stainless steel	24	2,40



Servierbrett „NARROW II“

serving board
tabla de servir
planche de service

Akazienholz, mit 3 Vertiefungen Ø 6 cm
acacia wood, with 3 notches Ø 6 cm
madera de acacia, con 3 ranuras Ø 6 cm
bois d'acacia, avec 3 encoches Ø 6 cm



	cm	↑ cm	€
00878	31 x 11	2,0	12,00

passende Schälchen / fitting bowls / cuencos adecuados / bols appropriés

	Ø cm	↑ cm	ltr.	VE / unit	€ / pc.	
40686	8	4,5	0,17	stainless steel	24	3,60



Salatbesteck „OLIVE“, 2er Set

spoon, 2 pcs.
cuchara, set de 2
cuillère, set de 2

aus Olivenholz
olive wood
madera de olivo
en bois d'olivier



	cm	→ cm	€ / set
00841	9,5 x 8,5	17,0	17,30
00842	7,5 x 6,0	22,5	11,00



Anwendungsbeispiel
application example



Anwendungsbeispiel
application example



Löffel „OLIVE“

spoon
cuchara
cuillère

aus Olivenholz, ideal für Reis, Gemüse...
olive wood, ideal for rice, vegetables...
madera de olivo, ideal para arroz, verduras...
en bois d'olivier, idéal pour le riz, les légumes...



	cm	→ cm	€
00840	9,5 x 8,5	17	16,00



Schaufel „OLIVE“

scoop
pala
pelle

aus Olivenholz, ideal für Gewürze, Körner etc.
olive wood, ideal for spices, grains etc.
madera de olivo, ideal para especias, granos etc.
en bois d'olivier, idéal pour les épices, céréales, etc.



	→ cm	€
01020	13,5	7,40





Löffel „OLIVE“, 2er Set

spoon, 2 pcs.
cuchara, set de 2
cuillère, set de 2

aus Olivenholz, ideal für Gewürze
olive wood, ideal for spices
madera de olivo, ideal para especias
en bois d'olivier, idéal pour les épices



	→ cm	pcs.	€ / set
01018	14	2	6,60



Honiglöffel „OLIVE“

honey spoon
cuchara de miel
cuillère à miel

aus Olivenholz
olive wood
madera de olivo
en bois d'olivier



	→ cm	€
01019	15	4,90



Löffel „ACACIA“

spoon
cuchara
cuillère

aus Akazienholz, ideal für Reis, Gemüse...
acacia wood, ideal for rice, vegetables...
madera de acacia, ideal para arroz, verduras...
bois d'acacia, idéal pour le riz, les légumes...



	cm	→ cm	€
00599	9 x 6,5	23,5	5,50

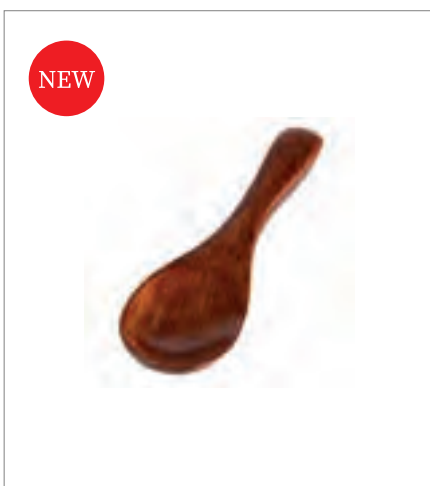

Löffel

spoon
cuchara
cuillère

Nanmu Holz / nanmu wood / madera de nanmu / bois de nanmu



	cm	→ cm	€
87027	3,5 x 3	10	3,00



Rindenbretter und Baumscheiben

Wenn es besonders zünftig sein darf, schaffen unsere Rindenbretter und Baumscheiben aus heimischem Erlenholz das passende rustikale Ambiente für Ihr Event. Jedes Exemplar ist ein Unikat und lebensmittelgerecht lackversiegelt, um einen langjährigen Einsatz zu gewährleisten. Mit unseren handgefertigten Brotzeitplatten bieten Sie Ihren Gästen ein natürliches Erlebnis beim Servieren schmackhafter Käse- und Wurstsorten.



Highlights in Kürze

- ▶ Gefertigt aus Erlenholz
- ▶ Lebensmittelgerecht lackversiegelt (TÜV Rheinland geprüft)
- ▶ Jedes Exemplar ist ein Unikat
- ▶ Rustikal einzigartig bei Brotzeitbuffets oder Brotzeitplatten
- ▶ Zum Servieren von Käse und Wurst
- ▶ Handgefertigt
- ▶ Aus heimischen Hölzern

Baumscheiben Erle

Art.-Nr.	Maße		EAN
30403	ca. 30×15 cm	mit Griff, lackiert	4250487132916
10631	ca. 38×17 cm	mit Griff, lackiert	4250487106528
30404	ca. 40×20 cm	mit Griff, lackiert	4250487104869
30405	ca. 50×25 cm	mit Griff, lackiert	4250487100588
30406	ca. 60×27 cm	mit Griff, lackiert	4250487100595
30407	ca. 70×29 cm	mit Griff, lackiert	4250487132923
30408	ca. 80×30 cm	mit Griff, lackiert	4250487132930
30409	ca. 90×35 cm	mit Griff, lackiert	4250487132947





Baumscheiben Erle

Art.-Nr.	Maße		EAN
30502	ca. 30×14 cm	oval, lackiert	4250487103992
30503	ca. 35×16 cm	oval, lackiert	4250487104876
30504	ca. 40×17 cm	oval, lackiert	4250487103985
10759	ca. 45×20 cm	oval, lackiert	4250487106740
30505	ca. 50×18 cm	oval, lackiert	4250487104333
10760	ca. 55×20 cm	oval, lackiert	4250487142663
30506	ca. 60×20 cm	oval, lackiert	4250487100601
30507	ca. 70×25 cm	oval, lackiert	4250487100618
30508	ca. 80×28 cm	oval, lackiert	4250487100625
30509	ca. 90×30 cm	oval, lackiert	4250487132954
30510	ca. 100×33 cm	oval, lackiert	4250487132961



Baumscheiben Esche/Erle

Art.-Nr.	Maße		EAN
10610	ca. 18–20 cm	rund, lackiert	4250487106467
30620	ca. 20–22 cm	rund, lackiert	4250487132978
30625	ca. 23–26 cm	rund, lackiert	4250487100649
30630	ca. 27–30 cm	rund, lackiert	4250487100656
30635	ca. 31–35 cm	rund, lackiert	4250487132985
30640	ca. 36–40 cm	rund, lackiert	4250487132992



TÜVRheinland[®]

Precisely Right.

Unikate aus Olivenholz

Der Olivenbaum wird seit dem 4. Jahrtausend vor Christus als Nutzpflanze kultiviert und verleiht ein einzigartiges mediterranes Ambiente. Das von uns bezogene Olivenholz stammt von bis zu 1.000 Jahre alten tunesischen Olivenbäumen, das sich auf vielfältige Weise für den Gebrauch im Lebensmittel- und Gastronomiebereich eignet. Ob als natürliches Salatbesteck, Schüssel, Eierbecher oder Griffbrett – das harte, widerstandsfähige Olivenholz ist für den professionellen Einsatz immer die richtige Wahl.

Highlights in Kürze

- ▶ Aus Tunesien stammend
- ▶ Von bis zu 1.000 Jahre alten Bäumen
- ▶ Individuelle und einzigartig natürliche Maserung
- ▶ Jedes Exemplar ist ein Unikat
- ▶ Mit Olivenöl eingelassen
- ▶ Durch Dichte und Härte des Holzes für den täglichen Gebrauch schnittunempfindlich
- ▶ Resistent gegen heißes Fett oder Geschirrspülmittel
- ▶ Zur Pflege nur mit natürlichem Speiseöl einlassen
- ▶ Maße sind Circa-Angaben und können variieren

Antipasti-Zubehör



Art.-Nr.	Maße		VE	EAN
13148	ca. 16×2 cm	Antipastipickser	10 Stück	4250487114318
13312	ca. 18×11 cm	Antipastischale groß oval	1 Stück	4250487105002
13311	ca. 16×10 cm	Antipastischale mittel oval	3 Stück	4250487114592
13310	ca. 14×8 cm	Antipastischale klein oval	3 Stück	4250487114585



Griffbretter

Art.-Nr.	Maße		VE	EAN
13176	30×13,5×2 cm	Griffbrett kantig	3 Stück	4250487114479
13175	34×16×2 cm	Griffbrett kantig	3 Stück	4250487114462
13174	40×18×2 cm	Griffbrett kantig	3 Stück	4250487114455
13170	23×11×1,2 cm	Griffbrett rundlich	3 Stück	4250487104838
13171	27×12×1,5 cm	Griffbrett rundlich	3 Stück	4250487114431
13712	30×14×1,5 cm	Griffbrett rundlich	3 Stück	4250487114615

Naturform-Griffbretter

Art.-Nr.	Maße		VE	EAN
13166	ca. 30×15 cm	Naturform-Griffbrett	3 Stück	4250487114424
13167	ca. 40×18 cm	Naturform-Griffbrett	3 Stück	4250487104951
13168	ca. 50×22 cm	Naturform-Griffbrett	1 Stück	4250487104968
13169	ca. 70×40 cm	Naturform-Griffbrett	1 Stück	4250487104340



Naturform-Schneidebretter

Art.-Nr.	Maße		VE	EAN
13181	ca. 40 cm	Naturform-Schneidebrett groß	3 Stück	4250487114493
13180	ca. 30 cm	Naturform-Schneidebrett klein	3 Stück	4250487114486

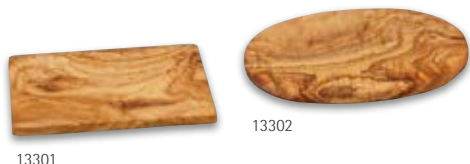

Frühstücksbretter

Art.-Nr.	Maße		VE	EAN
13301	15×25×1,5 cm	Frühstücksbrett eckig	3 Stück	4250487114561
13302	17×25×1,3 cm	Frühstücksbrett oval	3 Stück	4250487114578



Wurzelschüsseln

Art.-Nr.	Maße		VE	EAN
13192	ca. 30×18 cm	Wurzelschüssel mit Griff klein	1 Stück	4250487104975
13191	ca. 40×25 cm	Wurzelschüssel mit Griff groß	1 Stück	4250487137898



Schalen

Art.-Nr.	Maße		VE	EAN
13315	ca. 23×10 cm	Wellenschale	3 Stück	4250487114608
13318	ca. 46×8 cm	Baguetteschale	3 Stück	4250487104357
13320	ca. 30×20 cm	Brot und Obstschale	3 Stück	4250487104364



Obstschüsseln

Art.-Nr.	Maße		VE	EAN
13190	Ø 25 cm	Obstschüssel »rustical«	1 Stück	4250487114509



Salatschüsseln

Art.-Nr.	Maße		VE	EAN
13193	Ø 20/21 cm	Salatschüssel	1 Stück	4250487114516
13194	Ø 22/23 cm	Salatschüssel	1 Stück	4250487114523
13195	Ø 24/25 cm	Salatschüssel	1 Stück	4250487104982
13196	Ø 26/27 cm	Salatschüssel	1 Stück	4250487114530
13197	Ø 28/29 cm	Salatschüssel	1 Stück	4250487114547
13198	Ø 30/31 cm	Salatschüssel	1 Stück	4250487114554



Salatbesteck

Art.-Nr.	Maße	VE	EAN
13105	26 cm Salatbesteck »rustical«	5 Stück	4250487114158
13109	25 cm Salatbesteck	5 Stück	4250487114165
13110	30 cm Salatbesteck	5 Stück	4250487104937
13111	35 cm Salatbesteck	5 Stück	4250487114172



Kochlöffel

Art.-Nr.	Maße	VE	EAN
13140	30 cm Kochlöffel rund	10 Stück	4250487114264
13143	35 cm Kochlöffel rund	10 Stück	4250487114271
13137	30 cm Kochlöffel spitz	10 Stück	4250487137294
13138	30 cm Kochlöffel spitz mit Loch	10 Stück	4250487137300



Olivenlöffel

Art.-Nr.	Maße	VE	EAN
13147	17 cm Olivenlöffel	3 Stück	4250487104944



Gemüse-/Reislöffel

Art.-Nr.	Maße	VE	EAN
13101	26 cm Gemüse-/Reislöffel »rustical«	5 Stück	4250487114141



Esslöffel

Art.-Nr.	Maße	VE	EAN
13134	20 cm Esslöffel	10 Stück	4250487114257



Kinderlöffel

Art.-Nr.	Maße	VE	EAN
13132	13 cm Kinderlöffel	10 Stück	4250487114240



Marmeladenlöffel

Art.-Nr.	Maße	VE	EAN
13130	11 cm Marmeladenlöffel	10 Stück	4250487114233



Honigheber

Art.-Nr.	Maße	VE	EAN
13149	20×3,5 cm Honigheber groß	10 Stück	4250487114325
13150	15 cm Honigheber klein	10 Stück	4250487114332



Schöpfkellen

Art.-Nr.	Maße		VE	EAN
13144	25 cm	Schöpfkelle	3 Stück	4250487114288
13145	30 cm	Schöpfkelle	3 Stück	4250487114295
13146	35 cm	Schöpfkelle	3 Stück	4250487114301



Wender

Art.-Nr.	Maße		VE	EAN
13120	25 cm	Wender	10 Stück	4250487114189
13122	30 cm	Wender	10 Stück	4250487114196
13124	35 cm	Wender	10 Stück	4250487114202
13125	29×6,5 cm	Wender gebogen	10 Stück	4250487114219
13127	38 cm	Wok-Wender	10 Stück	4250487114226



Mörser

Art.-Nr.	Maße		VE	EAN
13160	Ø 8,5 cm	Mörser	3 Stück	4250487114370
13161	Ø 10 cm	Mörser	3 Stück	4250487114387
13162	Ø 12 cm	Mörser	3 Stück	4250487114394
13163	Ø 15 cm	Mörser	3 Stück	4250487114400



Knabberschalen

Art.-Nr.	Maße		VE	EAN
13201	Ø ca. 12 cm	Knabberschale	5 Stück	4250487104999
13164	Ø ca. 22 cm	Knabbertablett mit Griff	1 Stück	4250487114417



Eierbecher

Art.-Nr.	Maße		VE	EAN
13155	8 cm	Eierbecher	10 Stück	4250487114356



Zitronenpresse

Art.-Nr.	Maße		VE	EAN
13210	ca. 16 cm	Zitronenpresse	3 Stück	4250487137317



Nusschraube

Art.-Nr.	Maße		VE	EAN
13151	ca. 12×6 cm	Nusschraube Pilz	3 Stück	4250487114349

Holzmulden

Holzmulden

Art.-Nr.	Maße	VE	EAN
38120	23×17 cm versiegelt	1 Stück	4250487144322
38230	30×17 cm versiegelt	1 Stück	4250487104623
38237	37×20 cm versiegelt	1 Stück	4250487104753
38245	45×22 cm versiegelt	1 Stück	4250487104760
38250	50×25 cm versiegelt	1 Stück	4250487104777
38260	60×25 cm versiegelt	1 Stück	4250487104784
38270	70×25 cm versiegelt	1 Stück	4250487104791
38280	80×30 cm versiegelt	1 Stück	4250487104807
38290	90×30 cm versiegelt	1 Stück	4250487104814
38300	100×35 cm versiegelt	1 Stück	4250487104821



Essschaufel

Art.-Nr.	Maße	VE	EAN
38330	44×20 cm versiegelt	1 Stück	4250487100670



Antipastifässer

Oliven-/Antipastizuber



38301

Art.-Nr.	Maße		VE	EAN
38301	Ø 27 cm	Oliven-/Antipastizuber Eiche mit Kunststoffeinsatz	1 Stück	4250487100663
38303		Kunststoff-PET-Deckel für Art. 38301	1 Stück	4250487102520



38303

Antipasti Thekenholzfasser Fichtenholz gebeizt

Art.-Nr.	Volumen	Maße		VE	EAN
38302	1,3 l	Höhe 16 cm	mit Edelstahlschüssel	1 Stück	4250487102537
38306	1,3 l		Edelstahl-Ersatzschüssel	1 Stück	4250487143738
38310			Kunststoff-PET-Deckel für Holzuber (38302)	1 Stück	4250487154345
38304	2,5 l	Höhe 16 cm	mit Edelstahlschüssel	1 Stück	4250487138888
38307	2,5 l		Edelstahl-Ersatzschüssel	1 Stück	4250487147453
38305	3,5 l	Höhe 16 cm	mit Edelstahlschüssel	1 Stück	4250487138895
38308	3,5 l		Edelstahl-Ersatzschüssel	1 Stück	4250487147460

NEU!

Maße	innen	außen
oben	Ø 22,7 cm	Ø 25 cm
unten	Ø 18,5 cm	Ø 21,5 cm

38304



38305

Maße	innen	außen
oben	Ø 26,8 cm	Ø 29,5 cm
unten	Ø 22,6 cm	Ø 25,5 cm

38302

Maße	innen	außen
oben	Ø 18 cm	Ø 21,5 cm
unten	Ø 15 cm	Ø 18,5 cm

38310



NEU!



Steakteller



Art.-Nr.	Maße		VE	EAN
80550	Ø 25 cm	Steakteller	1 Stück	4250487103336
80551	Ø 30 cm	Steakteller	1 Stück	4250487103800



Steakbesteck Rustikal



Art.-Nr.		VE	EAN
14379	Steakbesteck Rustikal	6 Stück	4250487116589



Besteckzuber

Art.-Nr.	Maße		VE	EAN
50239	15×15×26 cm	geflammt	1 Stück	4250487139649
50238	20×20×28 cm	geflammt mit Salzaussparungen	1 Stück	4250487139571
50208	15×15×26 cm	Natur	1 Stück	4250487139519
50237	20×20×28 cm	Natur mit Salzaussparungen	1 Stück	4250487139618
50328	26×16×25 cm	geflammt mit Salzaussparungen und Serviettenhalterung Fichte lackiert	1 Stück	4250487152952
50329	26×16×25 cm	natur mit Salzaussparungen und Serviettenhalterung Fichte lackiert	1 Stück	4250487152969

NEU!

NEU!



Besteckfass

NEU!

Art.-Nr.	Maße		VE	EAN
50209	Ø 15 cm · Höhe 15 cm	Natur	1 Stück	4250487150255
50211	Ø 15 cm · Höhe 15 cm	geflammt	1 Stück	4250487153140



Tischaufsteller



Art.-Nr.	Maße		VE	EAN
50240	21×10 cm	Rustikal	1 Stück	4250487141024



Brotkörbe rustikal

Art.-Nr.	Maße		VE	EAN
90031318	40×30×12 cm	Brotkorb rustikal geflammt	11 Stück	4250487142137
90031319	35×30×12 cm	Brotkorb rustikal geflammt	11 Stück	4250487142144
90031320	30×25×12 cm	Brotkorb rustikal geflammt	11 Stück	4250487142151
90031321	30×30×40 cm	Baguettekorb rustikal	11 Stück	4250487142168

NEU!

Rinden-Tischaufsteller rustikal



39043

Art.-Nr.	Maße	VE	EAN
39043	Ø 10-12 cm Rindenscheiben Set	10 Scheiben + 50 Papierkarten	4250487150378
39044	17 x 12 cm Ersatzkarten Perlmutterpapier	50 Stück	4250487150385



39044



Rustikale Brozeitglocke

NEU!

Art.-Nr.	Maße	VE	EAN
53122	Ø ca. 30 x 25 cm Brotzeitglocke	1 Stück	4250487153294

NEU!

Brotzeitservierbretter

Art.-Nr.	Maße		VE	EAN
71021	42×26×2 cm	Servierplatte mit Griff Akazienholz geölt	1 Stück	4250487152853
71022	49×15×2 cm	Servierplatte mit Griff Akazienholz geölt	1 Stück	4250487152860
71023	40×20×1 cm	Rustikale Servierplatte mit Griffloch Akazienholz geölt	1 Stück	4250487152877
71024	Ø ca. 35×2 cm	Rustikale Servierplatte Akazienholz geölt	1 Stück	4250487152884
71025	53×38 cm	Schinken-/Käseservierplatte rund mit Griff Buchenholz geölt	1 Stück	4250487153423
71026	41×16 cm	Holztranchierplatte »Bank« dunkel rechteckig	1 Stück	4250487153430
71027	41×25 cm	Holztranchierplatte »Bank« dunkel rechteckig	1 Stück	4250487153447
71028	41×19×2 cm	Holztranchierbrett mit Griff rechteckig	1 Stück	4250487153454
71029	47×26×2 cm	Holztranchierbrett mit Griff rechteckig	1 Stück	4250487153539
71030	Ø ca. 34×15 cm	Rustikale Servierplatte Akazienholz geölt »Artikel kann leichte Risse aufweisen – Rustikal«	1 Stück	4250487153546
71031	40×49×2 cm	Schinken-/Käseservierplatte eckig mit Griff Akazienholz geölt	1 Stück	4250487153362
71032	60×47×4 cm	Schinken-/Käseservierplatte rund mit Griff Akazienholz geölt	1 Stück	4250487153379



71021



71031



71022



71023



71032



71025



71028

71029



71026



71027

71030



71024



Zubehör

Rund um den Tisch- und Servicebereich werden in jedem Gastronomiebetrieb eine Vielzahl an Zubehörartikeln eingesetzt, die sowohl nützlich als auch oft unverzichtbar sind: Von der Salz- und Pfeffermenage über Dipschälchen, Teelichthalter, Bonspieße, Speise- und Klemmbretter bis hin zum Kofferboy, Betttablett, Weinregal und Fichtenholzhocker finden Sie passende Ausstattungartikel in unserem umfangreichen Zubehörprogramm.

Tisch



Teelicht

Art.-Nr.	Maße		VE	EAN
18635	8×8×8 cm	Teelicht »1er«	4 Stück	4250487129589
18636	15×8×8 cm	Teelicht »2er«	2 Stück	4250487129596
18637	22×8×8 cm	Teelicht »3er«	2 Stück	4250487129602

Salz-/Pfeffermenage



Art.-Nr.	Maße		VE	EAN
50274	53×32,5×8 cm	dunkel	1 Stück	4250487141147
50275	32,5×26,5×8 cm	hell	1 Stück	4250487141154
50272	53×32,5×8 cm	mit Serviettenhalter dunkel	1 Stück	4250487141123
50273	32,5×26,5×8 cm	mit Serviettenhalter hell	1 Stück	4250487141130



50272



50275



50273



Speisebrett Naturell Rechteck

Art.-Nr.	Maße		VE	EAN
50271	38 × 20 cm	dunkel geölt (für Teller und Besteck)	1 Stück	4250487140102
50269	38 × 20 cm	hell geölt (für Teller und Besteck)	1 Stück	4250487140096
50270	38 × 24 cm	dunkel geölt (für Teller und Besteck)	1 Stück	4250487140126
50268	38 × 24 cm	hell geölt (für Teller und Besteck)	1 Stück	4250487140119
50290	33 × 20 cm	dunkel geölt	1 Stück	4250487139533
50289	33 × 20 cm	hell geölt	1 Stück	4250487139526

Kombidipbrett



Art.-Nr.	Maße		VE	EAN
50241	11 × 22 cm	Dunkel für runde Schalen	1 Stück	4250487140621
50242	11 × 22 cm	Dunkel geölt für quadratische Schalen	1 Stück	4250487140676
50292	11 × 22 cm	Natur für runde Schalen	1 Stück	4250487140614
50291	11 × 22 cm	Natur geölt für quadratische Schalen	1 Stück	4250487140669



Dipp Tablett Kunstschiefer



Art.-Nr.	Maße		VE	EAN
65700	27 × 10 cm	mit 3 Ausfräsungen Ø 6 cm und 5,5 cm	1 Stück	4250487141741

Holztablets



Art.-Nr.	Maße		VE	EAN
50281	30 × 20,5 cm	Eschenholz dunkel geölt	1 Stück	4250487140683
50297	30 × 20,5 cm	Eschenholz geölt	1 Stück	4250487140607
50295	26 × 26 × 2 cm	Nussbaum geölt	1 Stück	4250487140706
50298	30 × 20,5 cm	Nussbaum geölt	1 Stück	4250487140591
50296	35 × 16 × 2 cm	Nussbaum geölt	1 Stück	4250487140690

Brotsets mit Dipschälchen mit 3 Schälchen



Art.-Nr.	Maße		VE	EAN
50299	30 × 20,5 cm	Eschenholz geölt	1 Stück	4250487140652
50231	30 × 20,5 cm	Dunkel geölt	1 Stück	4250487140713
50300	30 × 20,5 cm	Nussbaum geölt	1 Stück	4250487140447
50312	6 × 6 × 6 cm	Porzellan Schale »Würfel« 100 ml Inhalt	1 Stück	4250487150132



50300

50231

Profirollen



Profirollen

Art.-Nr.	Maße		VE	EAN
14301	30×8 cm	Edelstahllager/-welle	1 Stück	4250487116121
14302	35×8 cm	Edelstahllager/-welle	1 Stück	4250487103688
14303	40×8 cm	Edelstahllager/-welle	1 Stück	4250487103695
14304	45×8 cm	Edelstahllager/-welle	1 Stück	4250487116138

Profi-Butcherblock aus Buchenholz, geölt



10992

Art.-Nr.	Maße		VE	EAN
10991	45×35×4 cm	eckig ohne Rille	1 Stück	4250487107099
10992	45×35×4 cm	eckig mit Rille	1 Stück	4250487107112
50204	40×40×4 cm	eckig mit Rille	1 Stück	4250487140935
50206	30×30×4 cm	eckig ohne Rille	1 Stück	4250487140959
50226	30×30×6 cm	eckig ohne Rille	1 Stück	4250487140966
50203	45×30×4 cm	eckig ohne Rille	1 Stück	4250487140928
50249	45×30×6 cm	eckig ohne Rille	1 Stück	4250487140980
50205	Ø 30×4 cm	rund ohne Rille	1 Stück	4250487140942
50227	Ø 30×6 cm	rund ohne Rille	1 Stück	4250487140973
10990	Ø 35×4 cm	rund ohne Rille	1 Stück	4250487107075



10991



50204



50206



50203



50205



10990

Schneidebretter und Teller



Fleischteller mit Rille
Schinkenteller mit Rille



Schinkenteller



Schneidebrett eckig



Schneidebrett mit Griff



Tranchierbrett eckig



10372



10371



10143



10460



10960



31503

31504



31501

31502



60111

60112



80551

80550

Art.-Nr.	Maße		VE	EAN
10501	Ø 24×2 cm	Fleischteller mit Rille	2 Stück	4250487139335
10502	Ø 26×2 cm	Fleischteller mit Rille	2 Stück	4250487139069
10503	Ø 28×2 cm	Fleischteller mit Rille	2 Stück	4250487139632
10351	Ø 20×1,5 cm	Schinkenteller mit Rille	10 Stück	4250487105538
10352	Ø 22×1,5 cm	Schinkenteller mit Rille	10 Stück	4250487105545
10353	Ø 24×1,5 cm	Schinkenteller mit Rille	10 Stück	4250487105552
10354	Ø 26×1,5 cm	Schinkenteller mit Rille	10 Stück	4250487105569
10355	Ø 28×1,5 cm	Schinkenteller mit Rille	2 Stück	4250487105576
10356	Ø 30×1,5 cm	Schinkenteller mit Rille	2 Stück	4250487105583
10312	Ø 22×1,5 cm	Schinkenteller	10 Stück	4250487105453
10314	Ø 26×1,5 cm	Schinkenteller	10 Stück	4250487105477
10315	Ø 28×1,5 cm	Schinkenteller	2 Stück	4250487105484
10316	Ø 30×1,5 cm	Schinkenteller	2 Stück	4250487105491
10318	Ø 35×1,5 cm	Schinkenteller	2 Stück	4250487105507
10210	16×25×1,5 cm	Schneidebrett eckig	10 Stück	4250487105279
10211	18×24×1,5 cm	Schneidebrett eckig	10 Stück	4250487105286
10212	19×28×1,5 cm	Schneidebrett eckig	10 Stück	4250487105293
10213	21×31×1,5 cm	Schneidebrett eckig	10 Stück	4250487105309
10215	26×38×1,5 cm	Schneidebrett eckig	2 Stück	4250487105323
10216	29×43×1,5 cm	Schneidebrett eckig	2 Stück	4250487105330
10250	14×32×1,5 cm	Schneidebrett mit Griff	10 Stück	4250487105347
10251	16×35×1,5 cm	Schneidebrett mit Griff	10 Stück	4250487105354
10252	18×37×1,5 cm	Schneidebrett mit Griff	10 Stück	4250487105361
10253	20×39×1,5 cm	Schneidebrett mit Griff	10 Stück	4250487105378
10254	22×42×1,5 cm	Schneidebrett mit Griff	2 Stück	4250487105385
10255	24×44×1,5 cm	Schneidebrett mit Griff	2 Stück	4250487105392
10915	30×20×2 cm	Tranchierbrett eckig	1 Stück	4250487106955
10916	40×26×2 cm	Tranchierbrett eckig	1 Stück	4250487104326
10918	60×40×2 cm	Tranchierbrett eckig	1 Stück	4250487104654
10372	23×15 cm	Holzbrettchen eckig Edelholz	10 Stück	4250487100250
10371	Ø 22 cm	Holzteller mit Rille Edelholz	10 Stück	4250487100243
10143	28×11 cm	Messerbrett inkl. Messer und Safrille	4 Stück	4250487100366
10460	40×24×1,5 cm	Grillbrett mit Rille und Griffloch	1 Stück	4250487105774
10960	31×20,5×1,5 cm	Messerbrett mit Messer und Rille	5 Stück	4250487107037
31503	ca. 20×30×1,5 cm	Schneidebrett-Thermobuchenholz oval, geölt	10 Stück	4250487142519
31504	ca. 19×28×1,5 cm	Schneidebrett-Thermobuchenholz eckig, geölt	10 Stück	4250487142526
31501	20×39×1,5cm	Griffbrett-Thermobuchenholz geölt	10 Stück	4250487142533
31502	21×31×1,5 cm	Schneidebrett-Thermobuchenholz eckig mit Griff, geölt	10 Stück	4250487142540
60111	39×24×2 cm	Grillbrett mit Rille und Griff	1 Stück	4250487141246
60112	Ø 30 cm	Steakbrett hell mit Rille	1 Stück	4250487141253
80550	Ø 25 cm	Steakteller	1 Stück	4250487103336
80551	Ø 30 cm	Steakteller	1 Stück	4250487103800



Teigschaber

Art.-Nr.	Maße		VE	EAN
14412	25×5 cm	Teigschaber Gummi	10 Stück	4250487116695
14409	25×5 cm	Teigschaber Gummi schmal	10 Stück	4250487138017



Backpinsel

Art.-Nr.	Maße		VE	EAN
14413	19×2 cm	Backpinsel rund	12 Stück	4250487116701
14432	20×5 cm	Backpinsel 2 Zoll	50 Stück	4250487116763
14431	20×3,5 cm	Backpinsel 1,5 Zoll	50 Stück	4250487116756
14430	20×2,5 cm	Backpinsel 1 Zoll	50 Stück	4250487116749



14758

Zimmertabletts



Art.-Nr.	Maße		VE	EAN
14756	50×32 cm	lackiert	2 Stück	4250487118040
14757	55×36 cm	lackiert	2 Stück	4250487118057
14758	60×39 cm	lackiert	2 Stück	4250487118064
14763	65×42 cm	lackiert	2 Stück	4250487118101
10983	31×31 cm	wengefarben lackiert	1 Stück	4250487100403
10984	38×15 cm	wengefarben lackiert	1 Stück	4250487100410
50232	37×37×2 cm	wengefarben	? Stück	4250487141000
50233	20×20×2 cm	wengefarben	? Stück	4250487141017
53203	55×33×5 cm	dunkel, hoch mit Griffen	1 Stück	4250487101097
53204	40×40×5 cm	dunkel, hoch mit Griffen	1 Stück	4250487101103

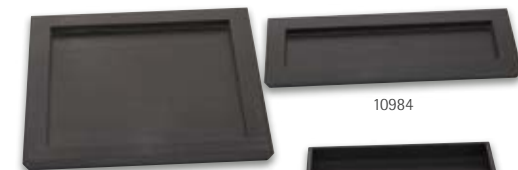

10983

10984



53203

53204



14756

Holztranchierbretter

Fleisch, Fisch, Geflügel aber auch Obst und Gemüse müssen im professionellen Gastronomiebereich einfach und ansprechend tranchiert werden. Das erfordert nicht nur scharfe Klingen, sondern auch harte Schnittunterflächen. Mit widerstandsfähigen Tranchierbrettern aus heimischen Buchen- und Eschenhölzern bieten wir Ihnen das harte und schnittfeste Fundament für jeden Anspruch. Die aus eigener Fertigung stammenden Thermo-Bretter und Belegeplatten verfügen über eine natürliche Fähigkeit zur Wärmespeicherung und halten damit Fleisch länger warm. Selbstverständlich erfüllen wir auch in diesem Bereich Ihren Wunsch nach Sonderformen mit unterschiedlicher Größe. Ihr Ammon Service-Team berät Sie gerne.

Highlights in Kürze

- ▶ Gefertigt aus heimischem Buchen- und Eschenholz
- ▶ Keilzinkenverleimt
- ▶ Geölt oder lebensmittelgerecht versiegelt
- ▶ Gebeizt oder Thermo
- ▶ Eigene Fertigung
- ▶ Sonderformen oder Maße möglich
- ▶ Immer Rohholz auf Lager



Thermotranchierbretter aus heimischem Buchenholz

Art.-Nr.	Maße		VE	EAN
50253	45×45×2 cm	Model CLASSIC	1 Stück	4250487139281
50252	65×40×2 cm	Model CLASSIC	1 Stück	4250487139458
50256	75×45×2 cm	Model GALA oval	1 Stück	4250487139465
50257	55×55×2 cm	Model GALA rund	1 Stück	4250487139472
50251	50×50×2 cm	Model SWING	1 Stück	4250487139441
50250	70×45×2 cm	Model SWING	1 Stück	4250487139274
50255	50×50×2 cm	Model Taille	1 Stück	4250487139496
50254	70×45×2 cm	Model Taille	1 Stück	4250487139298

Drehteller/Drehplatten

Art.-Nr.	Maße		VE	EAN
10580	Ø 34×6 cm	Teller mit Rille, gekerbter Rand	1 Stück	4250487106368
10581	Ø 44×6 cm	Teller mit Rille, gekerbter Rand	1 Stück	4250487106375
10582	Ø 54×6 cm	Teller mit Rille, gekerbter Rand	1 Stück	4250487106382
10590	Ø 48×4 cm	Teller mit Rille, lackiert Edelholz	1 Stück	4250487106399
10591	Ø 40×6 cm	Drehteller ohne Rille, lackiert Edelholz	1 Stück	4250487106405
50113	Ø 34×2 cm	Drehplatte hell mit Rille	1 Stück	4250487133869
50114	Ø 44×2 cm	Drehplatte hell mit Rille	1 Stück	4250487133876
50115	Ø 54×2 cm	Drehplatte hell mit Rille	1 Stück	4250487133883



Holzbelegplatten



53200



53201



53197



53198

Art.-Nr.	Maße		VE	EAN
53200	56×25×2 cm	Rechteck dunkel mit Rille	1 Stück	4250487134019
53201	56×25×2 cm	Rechteck hell mit Rille	1 Stück	4250487134026
53197	52×60×2 cm	Apfel hell	1 Stück	4250487101059
53198	68×45×2 cm	Birne hell	1 Stück	4250487101066
54101	80×40×2 cm	Rechteck dunkel mit Rille	1 Stück	4250487101127
51101	80×40×2 cm	Rechteck hell mit Rille	1 Stück	4250487133890
53112	67×46×2 cm	Gourmet dunkel mit Rille	1 Stück	4250487100977
51112	67×46×2 cm	Gourmet hell mit Rille	1 Stück	4250487100915
54102	75×40×2 cm	Rechteck dunkel mit Rille	1 Stück	4250487134101
53107	75×35×2 cm	Rechteck dunkel mit Rille	1 Stück	4250487100953
51107	75×35×2 cm	Rechteck hell mit Rille	1 Stück	4250487100908
53199	52×53×2 cm	Blatt hell	1 Stück	4250487101073
50210	68×46×2 cm	Blatt hell	1 Stück	4250487140256
80539	50×28×2 cm	Servierplatte oval aus Eschenholz mit Ausfräsung geölt »Massiv«	1 Stück	4250487143578
53129	62×28×2,3 cm	Holzbelegplatte »Buche« rechteckig mit Saftrille	1 Stück	4250487150187
53130	42×28×2,3 cm	Holzbelegplatte »Buche« rechteckig mit Saftrille	1 Stück	4250487149921

NEU!

NEU!



54101



51101



53112



51112



54102



53107



53199



50210



53250

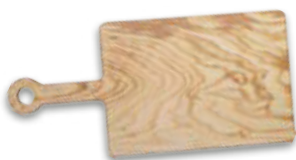

53253

Holztranchierbretter

NEU!

Art.-Nr.	Maße		VE	EAN
53250	52×25×2 cm	Profischneideservierbrett Buchenmultiplex geölt mit Griff	1 Stück	4250487147644
53251	82×25×2 cm	Profischneideservierbrett Buchenmultiplex geölt mit Griff	1 Stück	4250487147637
53252	100×40×2 cm	Profischneideservierbrett Buchenmultiplex geölt mit Griff	1 Stück	4250487147620
53253	35×25×2 cm	Profischneideservierbrett eckig Buchenmultiplex geölt mit Griff	1 Stück	4250487151849
80540	53×32,5×2 cm	Tranchierbrett aus Eschenholz hell, rechteckig mit Saftrille	1 Stück	4250487143561



Holzbelegplatten

Art.-Nr.	Maße		VE	EAN
53109	76×45×2 cm	Oval dunkel mit Rille	1 Stück	4250487133937
51109	76×45×2 cm	Oval hell mit Rille	1 Stück	4250487133906
53113	Ø 34×2 cm	Rund hell mit Rille	1 Stück	4250487133944
53118	Ø 44×2 cm	Rund hell mit Rille	1 Stück	4250487133951
53120	Ø 54×2 cm	Rund hell mit Rille	1 Stück	4250487133968
54115	Ø 58×2 cm	Sonne dunkel mit Rille	1 Stück	4250487134118
51115	Ø 58×2 cm	Sonne hell mit Rille	1 Stück	4250487133913
53101	60×43×2 cm	Traube dunkel	1 Stück	4250487100922
50212	60×43×2 cm	Traube hell	1 Stück	4250487140263
53110	68×46×2 cm	Eichel dunkel	1 Stück	4250487100960
53116	80×40×2 cm	Herbstlaub dunkel	1 Stück	4250487100236



53109



51109



53113



53118



53120



54115



51115



53101



50212



53110



53116

Fleischplatten

Art.-Nr.	Maße		VE	EAN
53313	55×32×2 cm	»gerundete Form« mit Griffen	1 Stück	4250487134095
53312	55×32×4 cm	»gerundete Form« mit Griffen	1 Stück	4250487134088
53311	65×35×4 cm	»gerundete Form« mit Griffen	1 Stück	4250487134071
53310	85×45×4 cm	»gerundete Form« mit Griffen	1 Stück	4250487134064



Spanferkelplatten

Art.-Nr.	Maße		VE	EAN
53300	100×50×2 cm	ohne Griffe mit Rille	1 Stück	4250487134033
53301	120×50×2 cm	ohne Griffe mit Rille	1 Stück	4250487101110
53302	120×50×4 cm	mit massiven Griffen	1 Stück	4250487134040
53303	110×60×4 cm	»gerundete Form« mit Rille	1 Stück	4250487134057
54101	80×40×2 cm	dunkel mit Rille	1 Stück	4250487101127



Pizzazubehör

Mit unserem Pizzazubehör holen Sie nicht nur italienisches Flair in Ihre Küche, sondern auch Profi-Qualität für Pizzabäcker: Pizza- und Flammkuchenbretter, Pizzateller, -rollen, -bleche und -wender sowie Brot- und Pizzaschieber sind strapazierfähig und spülmaschineneignet. Mit der Möglichkeit zum Werbeeinbrand sowie individuellen Sonderformen veredeln wir Ihr Pizzazubehör nach Ihren Wünschen. Mit Ammon Pizzazubehör sind Sie bereit für »la dolce vita«.

Highlights in Kürze

- ▶ Strapazierfähig
- ▶ Spülmaschinenfähig
- ▶ Werbeeinbrand möglich
- ▶ Sonderformen möglich



Pizza- und Flammkuchenbretter



Art.-Nr.	Maße		VE	EAN
10476	Ø 25×34 cm	rund mit Griff, Birkenmultiplex hell	1 Stück	4250487103763
10477	Ø 32×42 cm	rund mit Griff, Birkenmultiplex hell	1 Stück	4250487103770
10474	50×31 cm	gerundet mit Griff, Birkenmultiplex hell	1 Stück	4250487105880
60155	56×31 cm	Pizzabrett Vollbuchenholz geölt, rundum angeschrägt	1 Stück	4250487140232
80562	50×31×0,4 cm	rechteckig mit Griff, Kunststoff Holzoptik	1 Stück	4250487102452
50260	65×27 cm	Rechteckig mit Griff, Birkenmultiplexholz	10 Stück	4250487140805
50259	32×42×0,4 cm	Rund mit Griff, Kunststoff Holzoptik	1 Stück	4250487140812
80560	40×30 cm	Flammkuchenbrett mit Griff	10 Stück	4250487103510
80561	40×30 cm	Flammkuchenbrett ohne Griff	10 Stück	4250487103855
50403	48×25 cm	Flammkuchenbrett mit Griff Birkenmultiplex	1 Stück	4250487147682
50409	35×19 cm	Flammkuchenbrett »Le Petit« mit Griff	5 Stück	4250487151818





Pizzateller Buche

Art.-Nr.	Maße		VE	EAN
10479	Ø 30×1,5 cm	Pizzateller	5 Stück	4250487138178
60115	Ø 40×2 cm	Classic	1 Stück	4250487141260
60116	Ø 40×2 cm	Modern	1 Stück	4250487141277



Pizzarollen und -wender



Art.-Nr.	Maße		VE	EAN
14284	40×4 cm	Pizzarolle	5 Stück	4250487116077
14285	48×4 cm	Pizzarolle	5 Stück	4250487116084
14171	38×11 cm	Pizzawender	10 Stück	4250487115391



Profirollen

Art.-Nr.	Maße		VE	EAN
14301	30×8 cm	Edelstahlager/-welle	1 Stück	4250487116121
14302	35×8 cm	Edelstahlager/-welle	1 Stück	4250487103688
14303	40×8 cm	Edelstahlager/-welle	1 Stück	4250487103695
14304	45×8 cm	Edelstahlager/-welle	1 Stück	4250487116138



Pizzabretter Multiplex



Art.-Nr.	Maße		VE	EAN
50410	Ø 30×0,8 cm	Ahornmultiplex natur	1 Stück	4250487152471
50411	Ø 40×0,8 cm	Ahornmultiplex natur	1 Stück	4250487152488
50407	Ø 50×0,8 cm	Ahornmultiplex natur	1 Stück	4250487151443
50408	Ø 60×0,8 cm	Ahornmultiplex natur	1 Stück	4250487151764



Pizzazubehör



Art.-Nr.	Maße		VE	EAN
50627	60×16 cm	Griffbrett Birkenmultiplex, 9 mm stark	1 Stück	4250487143394
50629	51×30×0,8 cm	Flammkuchenbrett oval mit Griff, Birkenmultiplex hell	1 Stück	4250487144810
14415	17×6 cm	Pizzaschneider	10 Stück	4250487116725
14416	25×10 cm	Pizzaschneider »Gigant Profi«	1 Stück	4250487144827



Pizzazubehör



Art.-Nr.	Maße		VE	EAN
50320	40×40×1,80 m	Brot-/Pizzaschaufel »Profi« Vollbuchenholz »massiv«	1 Stück	4250487144643
50400	Ø 40×1 cm	Pizzateller Multiplex geölt	1 Stück	4250487147651
50401	50×31 cm	Flammkuchenbrett mit Griff	1 Stück	4250487147668
50402	40×30 cm	Flammkuchenbrett mit Loch eckig	1 Stück	4250487147675
50403	48×25 cm	Flammkuchenbrett mit Griff	1 Stück	4250487147682



Pizzableche mit Antihafbeschichtung · 250° C hitzebeständig



Art.-Nr.	Maße		VE	EAN
3439	ca. Ø 31,5×1,5 cm	Pizzablech rund »anthrazit-metallic«	1 Stück	4250487153096
3440	ca. Ø 32,0×3,0 cm	Pizzablech rund »anthrazit-metallic«	1 Stück	4250487153102



Pizzablech Emaille · 400° C hitzebeständig



Art.-Nr.	Maße		VE	EAN
3460	ca. Ø 31,0×1,5 cm	Pizzablech rund »Emaille«	1 Stück	4250487153126
3461	ca. Ø 32,0×3,0 cm	Pizzablech rund »Emaille«	1 Stück	4250487153133

hochwertig emailliert · schwarz gesprenkelt · in Profi-Qualität · extra stark schnittfeste Oberfläche · deutsches Markenprodukt

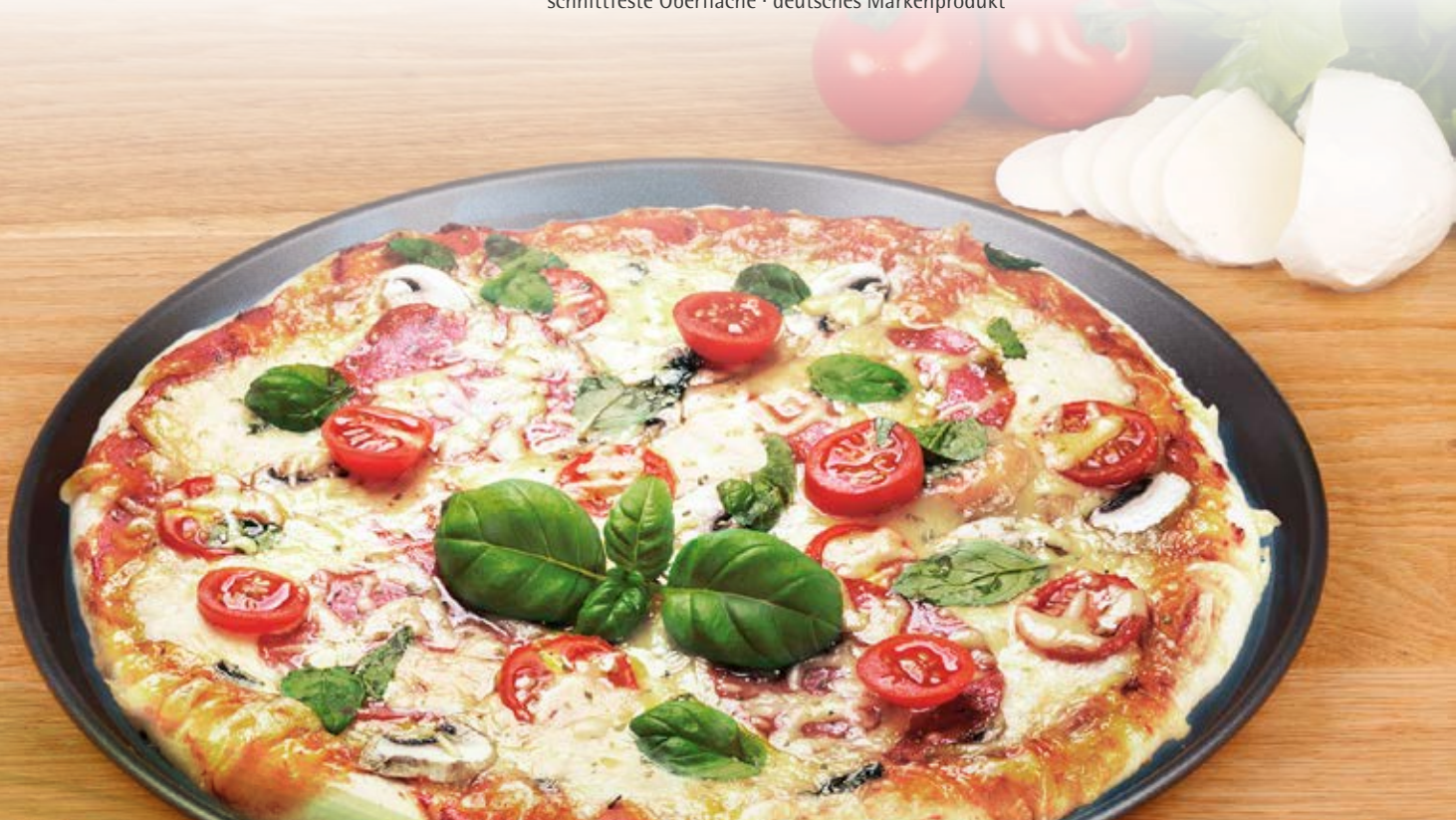

Pide-/Pizzaschieber

NEU!



Art.-Nr.	Maße		VE	EAN
50321	65×25 cm Gesamtlänge 86 cm	Pideschieber »Griffbrett« Buchenholz	1 Stück	4250487151450
50322	70×18 cm Gesamtlänge 92 cm	Pideschieber »Griffbrett« Buchenholz	1 Stück	4250487151474
50323	60×20 cm Gesamtlänge 1,60 m	Pideschieber mit »Stiel abnehmbar«	1 Stück	4250487151481
50324	80×20 cm Gesamtlänge 1,80 m	Pideschieber mit »Stiel abnehmbar«	1 Stück	4250487151498
50325	100×20 cm Gesamtlänge 2 m	Pideschieber mit »Stiel abnehmbar«	1 Stück	4250487151504

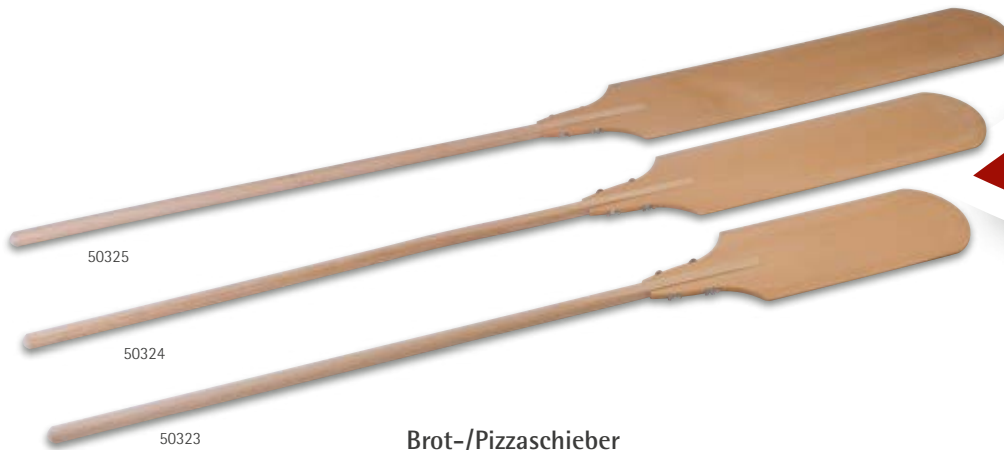

Brot-/Pizzaschieber



NEU!

Art.-Nr.	Maße		VE	EAN
50263	31×34 cm Länge: 2 m	Alu/Holz, eckig	1 Stück	4250487141109
50262	Ø 40 cm Länge: 2 m	Alu/Holz, rund	1 Stück	4250487141093
50264	Ø 30 cm Länge: 1,80 m	Edelstahl »Profi«	1 Stück	4250487141116





www.thekenplan.eu
vom Besten das Passende - für Theke und Catering

Optimierte Thekengestaltung

-  Passendes für jede Thekentiefe
-  Detaillierte Thekenpläne
-  Fläche = Nutzen optimieren
-  Winkellösungen
-  die größte Formenvielfalt
-  Kontakt zu den Präsentationsberatern
-  Wechselbelegungen
-  Heißtheke
-  Verkaufsfahrzeuge/mobile Theken
-  Wir schaffen den Unterschied zum Supermarkt

Lieferant für

-  Melamin in Porzellanoptik
-  Bruchfestes Cateringgeschirr
-  Platten und Becken in nahezu allen Abmessungen aus Kunststoff
-  Ceramic
-  Hottys für die Heißtheke
-  Flexy Pan
GN-Schalen aus Silikon
-  Theken- und Buffetzubehör
Preisauszeichnungen
-  Thekentrennscheiben
-  Transportbehälter und Sonderzubehör
-  Zuschnitte in Acryl und Kunstschiefer

**Alle angegebenen Preise sind netto-Preise pro Stück
- ohne Mehrwertsteuer**

Adressdatensatz:



Wir behalten uns das Recht vor, die Spezifikationen jederzeit zu ändern.
© COPYRIGHT - Die Vervielfältigung dieses Kataloges - auch wenn partial - muss ausschließlich von Stephan Kruis - Thekenplan genehmigt werden.

